



Programming Guide

VLT[®] PROFIBUS DP MCA 101

VLT[®] Frequency Converter Series FC 102 • FC 103 • FC 202
FC 301/302 • FCD 302 • FCP 106 • FCM 106



Contents

1 Introduction	3
1.1 Purpose of the Manual	3
1.2 Additional Resources	3
1.3 Document and Software Version	3
1.4 Product Overview	3
1.5 Approvals and Certifications	4
1.6 Symbols, Abbreviations, and Conventions	5
2 Safety	6
2.1 Safety Symbols	6
2.2 Qualified Personnel	6
2.3 Safety Precautions	6
3 Configuration	8
3.1 Configure the PROFIBUS Network	8
3.2 Configure the Master	9
3.2.1 GSD File	9
3.3 Configure the Frequency Converter	11
3.3.1 Frequency Converter Parameters	11
3.3.2 LEDs	12
4 Control	13
4.1 PPO Types	13
4.2 Process Data	15
4.2.1 Process Control Data	15
4.2.2 Process Status Data	15
4.2.3 Reference Handling	15
4.2.4 Process Control Operation	16
4.2.5 Influence of the Digital Input Terminals on FC Control Mode	16
4.3 Control Profile	16
4.4 PROFIdrive Control Profile	17
4.4.1 Control Word According to PROFIdrive Profile (CTW)	17
4.4.2 Status Word According to PROFIdrive Profile (STW)	18
4.4.3 PROFIdrive State Transition Diagram	20
4.5 Danfoss FC Control Profile	21
4.5.1 Control Word According to FC Profile (CTW)	21
4.5.2 Status Word According to FC Profile (STW)	22
4.6 Synchronize and Freeze	23
4.6.1 Sync/Unsync	23
4.6.2 Freeze/Unfreeze	24

5 Parameter Access	25
5.1 Parameter Access in General	25
5.2 DP-V1 Parameter Access	25
5.3 PCV Parameter Access	31
5.4 PROFIBUS DP Parameter and Data Type	33
6 Parameters	36
6.1 8-** PROFIBUS Parameters	36
6.2 9-** and 16-** PROFIBUS Parameters	39
6.3 PROFIBUS-specific Parameter List	46
7 Application Examples	48
7.1 Example 1: Process Data with PPO Type 6	48
7.2 Example 2: Control Word Telegram using PPO Type	49
7.3 Example 3: Status Word Telegram using PPO Type	50
7.4 Example 4: PLC Programming	51
8 Troubleshooting	53
8.1 Diagnosis	53
8.2 No Response to Control Signals	53
8.3 Warnings and Alarms	56
8.4 Fault Messages via DP Diagnosis	58
8.5 Extended Diagnosis	59
Index	60

1 Introduction

1.1 Purpose of the Manual

The *VLT® PROFIBUS DP MCA 101 Programming Guide* provides information about:

- Configuring the system.
- Controlling the frequency converter.
- Parameter access.
- Programming.
- Troubleshooting.
- Typical application examples.

The *programming guide* is intended for use by qualified personnel familiar with the VLT® frequency converter, with PROFIBUS technology, and with the PC or PLC used as a master in the system.

Read the instructions before programming and follow the procedures in this manual.

VLT® is a registered trademark.

1.2 Additional Resources

Resources available for the frequency converters and optional equipment:

- The *VLT® Operating Instructions* provide the necessary information for getting the frequency converter up and running.
- The *VLT® Design Guide* provides detailed information about capabilities and functionality to design motor control systems.
- The *VLT® Programming Guide* provides greater detail on working with parameters and many application examples.
- The *VLT® PROFIBUS DP MCA 101 Installation Guide* provides information about installing the PROFIBUS and troubleshooting.
- The *VLT® PROFIBUS DP MCA 101 Programming Guide* provides information about configuring the system, controlling the frequency converter, parameter access, programming, troubleshooting, and some typical application examples.

Supplementary publications and manuals are available from Danfoss. See vlt-drives.danfoss.com/Support/Technical-Documentation/ for listings.

1.3 Document and Software Version

This manual is regularly reviewed and updated. All suggestions for improvement are welcome. *Table 1.1* shows the document version and the corresponding software version.

Edition	Remarks	Software version
MG37G2xx	<ul style="list-style-type: none"> • Information about VLT® DriveMotor FCP 106/FCM 106 added. • New feature for fast PCD communication for MCO 305. 	5.20

Table 1.1 Document and Software Version

1.4 Product Overview

1.4.1 Features of PROFIBUS DP-V1

- 2 different state machines can be selected: PROFIdrive profile or Danfoss FC profile.
- Communication using PROFIBUS DP-V1, master class 1, and master class 2.
- Backward compatibility: New protocol extensions retain all the functions of the previous versions.
- Intelligent base for future technologies such as OPC, FDT/DTM, PROFINET.
- Bus timeout reaction.
- PLC/CPU stop reaction.
- 8 PPO types available.
- Numerous relevant process data (PCD) types available.
- Automatic detection of baud rate and PPO type.
- Extended diagnosis available.
- Alarms and warnings available as text messages within the PLC.
- Configuration via MCT 10 Set-up Software.
- Equally long bus cycle time configurable in PLC system.
- Improved network efficiency, since the cyclic parameter channel is no longer required.
- Short bus cycle times compared to industrial Ethernet.
- Backwards compatibility with DP.

1.4.2 Technical Overview

PROFIBUS

PROFIBUS is an international standard for fieldbus communication in automation technology (IEC 61158 and IEC 61784). The member companies of the PROFIBUS International User Community support the standard.

For information about PROFIBUS and downloads for PROFIBUS DP and the PROFIdrive profile, refer to www.Profibus.com.

PROFIBUS DP-V1

The PROFIBUS DP protocol enables communication between PROFIBUS masters and slaves.

Configure communication via MCT 10 Set-up Software.

Cyclic/acyclic communication

- PLC communicates with telegrams of constant length.
- Fits time-critical requirements.
- Cyclic transmission via PPO types.
- Extended diagnosis.

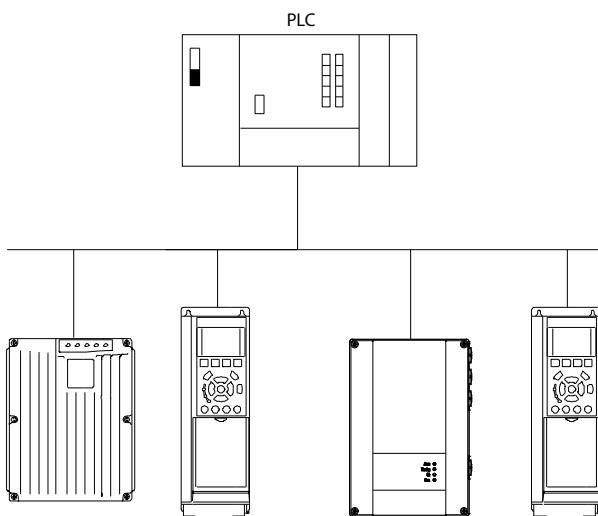

Illustration 1.1 PROFIBUS DP-V0

Features of a master class 1 connection:

- Cyclic data exchange (DP-V0).
- Acyclic read/write on parameters.
- Extended diagnosis.

The acyclic connection is fixed and cannot be changed during operation.

Features of a master class 2 connection:

- Initiate/abort acyclic connection.
- Acyclic read/write on parameters.

The acyclic connection can be established (initiated) or removed (aborted) dynamically even when a master class 1 is active on the network. Use the DP-V1 acyclic connection

for general parameter access as an alternative to the PCV parameter channel.

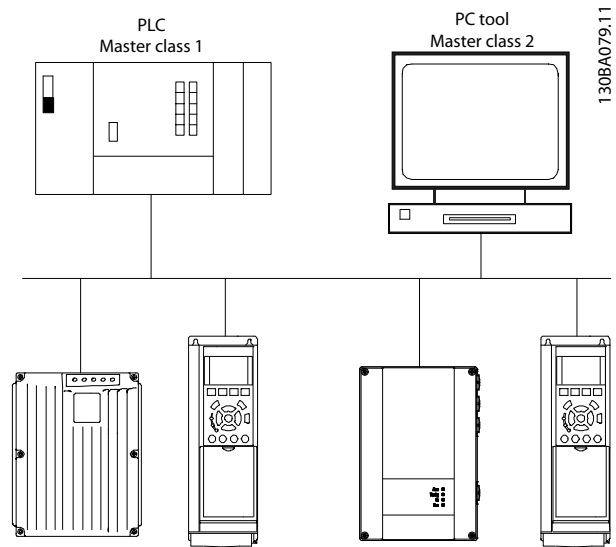

Illustration 1.2 PROFIBUS DP-V1

The PROFIBUS DP extension DP-V1 allows acyclic as well as cyclic data communication. This feature can be used by a DP master class 1, for example PLC, as well as a DP master class 2, for example PC tool.

1.5 Approvals and Certifications



More approvals and certifications are available. For more information, contact a local Danfoss partner.

1.6 Symbols, Abbreviations, and Conventions

CAN	Controller area network
CTW	Control word
DP	Distributed periphery
DTM	
DU	Data unit
EEPROM	Electrical erasable programmable read-only memory
EMC	Electromagnetic compatibility
FDT	Field device tool
HMI	
IND	Sub index
LCD	Liquid crystal display
LCP	Local control panel
LED	Light emitting diode
MAV	Main actual value
MC1	Master class 1
MC2	Master class 2
MRV	Main reference value
OPC	
PC	Personal computer
PCD	Process data
PCA	Parameter characteristics
PCV	Parameter characteristics value
PDU	Protocol data unit
PLC	Programmable logic control
PNU	Parameter number
PPO	Parameter-process data
PVA	Parameter value
RC	Request/response characteristics
SAP	Service access point
SMP	Spontaneous message
STW	Status word

Table 1.2 Symbols and Abbreviations

Conventions

Numbered lists indicate procedures.

Bullet lists indicate other information and description of illustrations.

Italicized text indicates:

- Cross-reference.
- Link.
- Footnote.
- Parameter name.
- Parameter group name.
- Parameter option.

* indicates a default setting in a parameter.

2

2 Safety

2.1 Safety Symbols

The following symbols are used in this manual:

⚠ WARNING

Indicates a potentially hazardous situation that could result in death or serious injury.

⚠ CAUTION

Indicates a potentially hazardous situation that could result in minor or moderate injury. It can also be used to alert against unsafe practices.

NOTICE

Indicates important information, including situations that can result in damage to equipment or property.

2.2 Qualified Personnel

Correct and reliable transport, storage, installation, operation, and maintenance are required for the trouble-free and safe operation of the frequency converter. Only qualified personnel are allowed to install and operate this equipment.

Qualified personnel are defined as trained staff, who are authorized to install, commission, and maintain equipment, systems, and circuits in accordance with pertinent laws and regulations. Also, the qualified personnel must be familiar with the instructions and safety measures described in these operating instructions.

2.3 Safety Precautions

⚠ WARNING

HIGH VOLTAGE

Frequency converters contain high voltage when connected to AC mains input, DC supply, or load sharing. Failure to perform installation, start-up, and maintenance by qualified personnel can result in death or serious injury.

- Only qualified personnel must perform installation, start-up, and maintenance.

⚠ WARNING

UNINTENDED START

When the frequency converter is connected to AC mains, DC supply, or load sharing, the motor may start at any time. Unintended start during programming, service, or repair work can result in death, serious injury, or property damage. The motor can start with an external switch, a fieldbus command, an input reference signal from the LCP or LOP, via remote operation using MCT 10 Set-up Software, or after a cleared fault condition.

To prevent unintended motor start:

- Press [Off/Reset] on the LCP before programming parameters.
- Disconnect the frequency converter from the mains.
- Completely wire and assemble the frequency converter, motor, and any driven equipment before connecting the frequency converter to AC mains, DC supply, or load sharing.

⚠ WARNING

DISCHARGE TIME

The frequency converter contains DC-link capacitors, which can remain charged even when the frequency converter is not powered. High voltage can be present even when the warning LED indicator lights are off. Failure to wait the specified time after power has been removed before performing service or repair work can result in death or serious injury.

- Stop the motor.
- Disconnect AC mains and remote DC-link power supplies, including battery back-ups, UPS, and DC-link connections to other frequency converters.
- Disconnect or lock PM motor.
- Wait for the capacitors to discharge fully. The minimum duration of waiting time is specified in the *chapter Safety* in the *operating instructions* supplied with the frequency converter.
- Before performing any service or repair work, use an appropriate voltage measuring device to make sure that the capacitors are fully discharged.

⚠ WARNING**LEAKAGE CURRENT HAZARD**

Leakage currents exceed 3.5 mA. Failure to ground the frequency converter properly can result in death or serious injury.

- Ensure the correct grounding of the equipment by a certified electrical installer.

⚠ WARNING**EQUIPMENT HAZARD**

Contact with rotating shafts and electrical equipment can result in death or serious injury.

- Ensure that only trained and qualified personnel perform installation, start-up, and maintenance.
- Ensure that electrical work conforms to national and local electrical codes.
- Follow the procedures in this guide.

⚠ CAUTION**INTERNAL FAILURE HAZARD**

An internal failure in the frequency converter can result in serious injury when the frequency converter is not properly closed.

- Ensure that all safety covers are in place and securely fastened before applying power.

3 Configuration

3

3.1 Configure the PROFIBUS Network

Ensure that all PROFIBUS stations connected to the same bus network have a unique station address.

Select the PROFIBUS address of the frequency converter via:

- Hardware switches.
- *Parameter 9-18 Node Address.*
- The PROFIBUS command SSA (set station address).

3.1.1 Setting the PROFIBUS Address using the DIP Switches

To set the PROFIBUS address using the DIP switches:

1. Switch off the supply.
2. Select an address in the range 0–125. Factory setting is 127.
3. For location of the DIP switches, refer to *Illustration 3.1* and *Illustration 3.2*.
4. Set the switches according to the address, see *Table 3.1*.

Switch	8	7	6	5	4	3	2	1
Address value	Not used	+64	+32	+16	+8	+4	+2	+1
5	Not used	OFF	OFF	OFF	OFF	ON	OFF	ON
35	Not used	OFF	ON	OFF	OFF	OFF	ON	ON
82	Not used	ON	OFF	ON	OFF	OFF	ON	OFF

Table 3.1 Examples: Setting the PROFIBUS Address using the DIP Switches

NOTICE

Switch off the supply before changing the DIP switches.

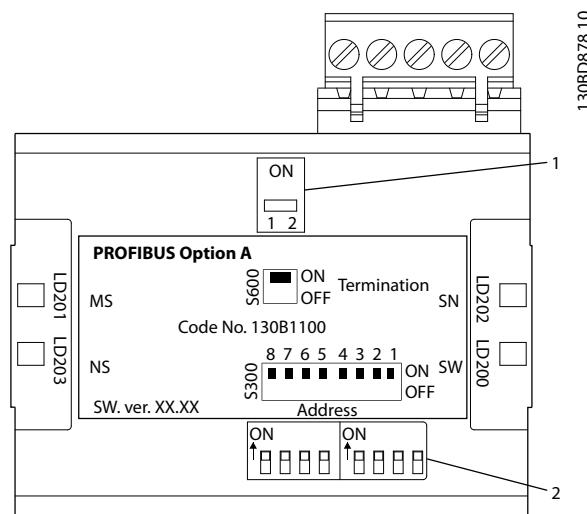

1	Termination switch
2	DIP switches

Illustration 3.1 Location and Sequence of the DIP Switches

The DIP switches in the FCD 302 are placed below the inverter part, see *Illustration 3.2*.

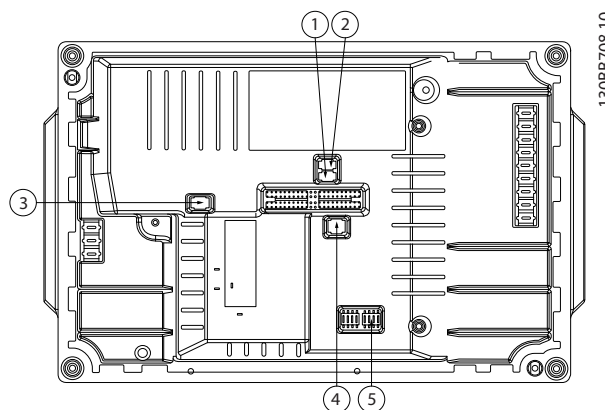

Illustration 3.2 FCD 302 Dip Switches

Setting the PROFIBUS address via parameter 9-18 Node Address

1. Switch off the supply.
2. Set the DIP switch to 126 or 127 (factory switch setting).
3. Set the address via *parameter 9-18 Node Address* or the PROFIBUS SSA-command.
4. The address change comes into effect at the next power-up.

Setting the PROFIBUS address with set station address command

1. Switch off the supply.
2. Set the DIP switch to 126 or 127 (factory switch setting).
3. Set the address via the set station address command. Use the set station address command to lock the programmed address and to change the address. To unlock the address setting, change *parameter 9-18 Node Address* or the address switch, followed by a power cycle. A new address is effective immediately after applying the set station address command.

3.2 Configure the Master

3.2.1 GSD File

To configure a PROFIBUS master, the configuration tool needs a GSD file for each type of slave on the network. The GSD file is a PROFIBUS DP standard text file containing the necessary communications set-up data for a slave. Download the GSD file for the relevant frequency converter series vlt-drives.danfoss.com/products/engineering-software/software-download/fieldbus/.

PROFIBUS SW version (parameter 15-61 Option SW Version)	GSD file
1.x	da01040A.GSD
2.x	da02040A.GSD
FCD 302	da01040B.GSD

Table 3.2 GSD File

The following example shows the procedure of configuring a PROFIBUS master for FC 301/FC 302, but the procedure is also valid for other frequency converter series.

1. Import the GSD file in the configuration tool.
2. Import the GSD file to the Simatic Manager software tool. Import a GSD file once only for each frequency converter series, following the initial installation of the software tool. See *Illustration 3.3*.
3. Use the browser for the GSD file, install all files, and import both a GSD file and a bitmap for the device into the hardware catalog. See *Illustration 3.4* and *Illustration 3.5*.

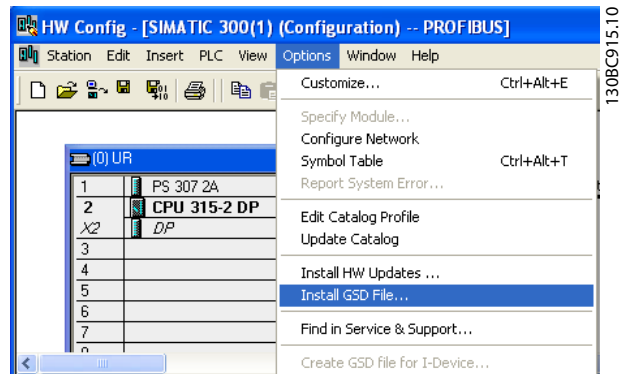

Illustration 3.3 Install GSD File

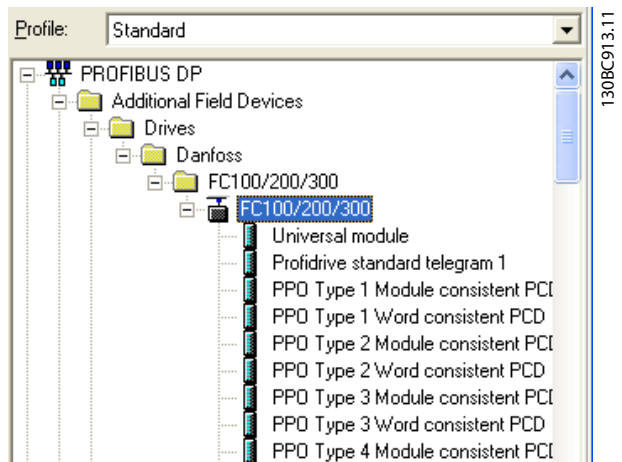

Illustration 3.4 Import a GSD File and a Bitmap

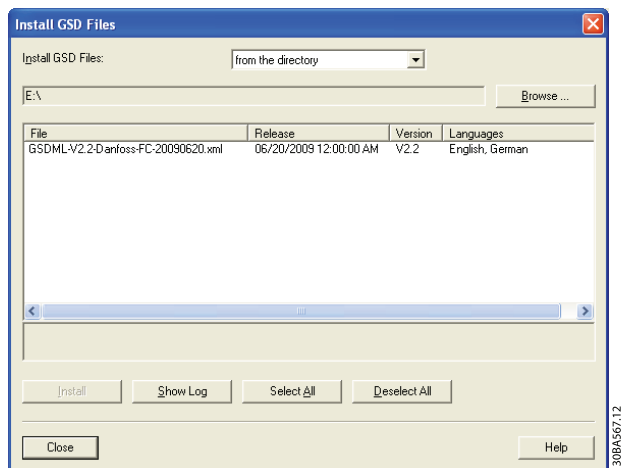

Illustration 3.5 Add a GSD File

- Import and access the FC 301/FC 302 GSD file via the path in the hardware catalog, see *Illustration 3.6*.

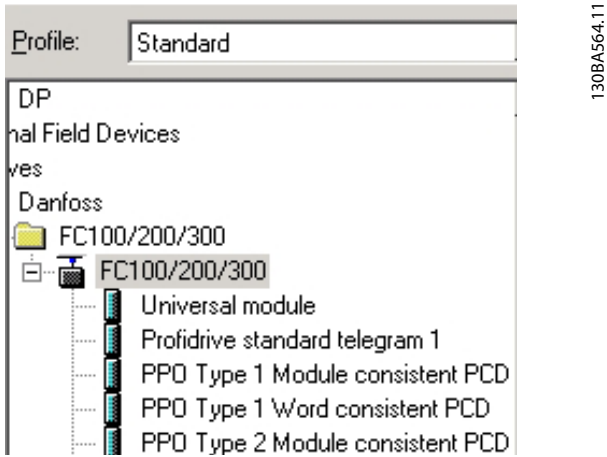

Illustration 3.6 Import and Access the GSD File

- Open a project, set up the hardware, and add a PROFIBUS master system.
- Select FC 300, then drag and drop it onto the PROFIBUS in the hardware diagram.
- A window for the address of the FC 300 appears. Select the address from the scroll-down list. Ensure that the address setting matches the previous address setting in *parameter 9-18 Node Address*. See *Illustration 3.7*.

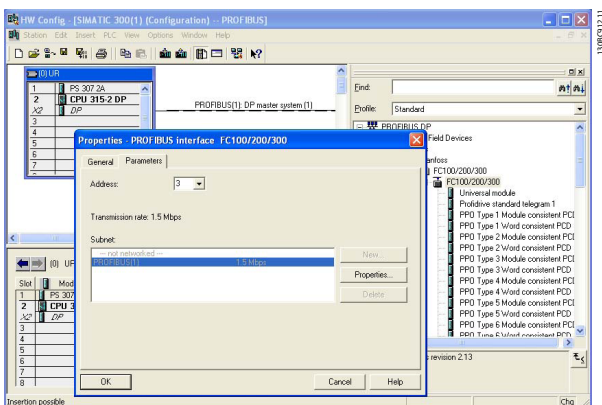

Illustration 3.7 Select the Address

- Set up the peripheral input and output data. Data set up in the peripheral area is transmitted cyclically via PPO types. Drag and drop a PPO type 6 word consistent to the first slot, see *Illustration 3.8*. See the PPO types in *chapter 4 Control* for more information.

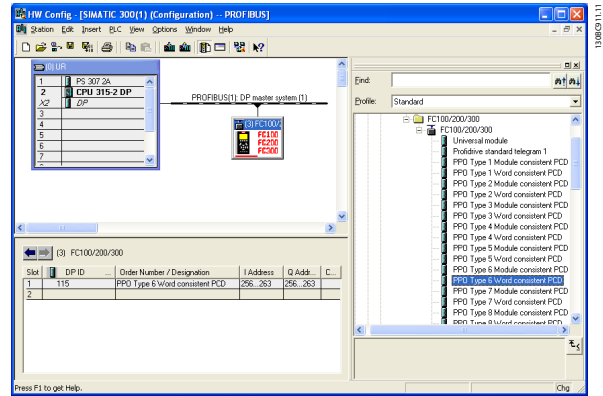

Illustration 3.8 Drag and Drop PPO Type 6 Word Consistent to the First Slot

The configuration tool automatically assigns addresses in the peripheral address area. In this example, the input and output areas have the following configurations:

PPO type 6

PCD word number	1	2	3	4
Input address	256–257	258–259	260–261	262–263
Set-up	STW	MAV	Parameter 9-16 PCD Read Configuration.2	Parameter 9-16 PCD Read Configuration.3

Table 3.3 PCD Read (Frequency Converter to PLC)

PCD word number	1	2	3	4
Output address	256–257	258–259	260–261	262–263
Set-up	CTW	MRV	Parameter 9-15 PCD Write Configuration.2	Parameter 9-15 PCD Write Configuration.3

Table 3.4 PCD Write (PLC to Frequency Converter)

Alternative: For PROFIBUS SW version 2.x and higher, auto-configuration of process data is supported. This feature makes it possible to configure the process data (*parameter 9-15 PCD Write Configuration* and *parameter 9-16 PCD Read Configuration*) from the PLC/master. To use auto-configuration, make sure to enable the feature under *DP slave properties*. See *Illustration 3.9*.

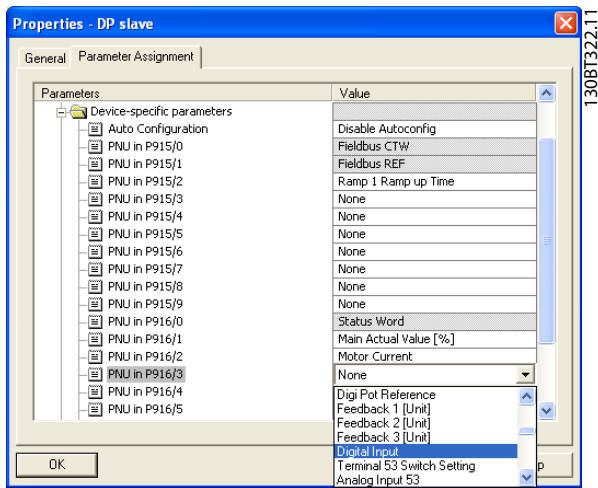

Illustration 3.9 Enable Feature under DP Slave Properties

NOTICE

DP-V1 diagnosis is supported for PROFIBUS SW version 2.x and higher. The default setting of the VLT® PROFIBUS DP MCA 101 is DP-V1 diagnosis. If DP-V0 diagnosis is required, change the setting under *DP slave properties*.

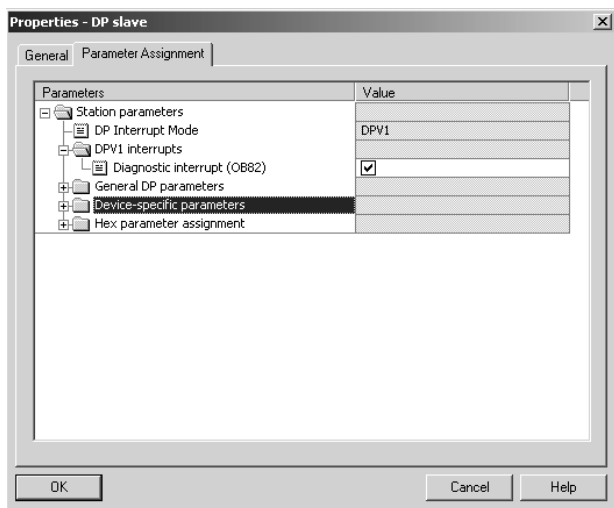

Illustration 3.10 DP-V1 Diagnosis

Download the configuration file to the PLC. The PROFIBUS system is able to go online, and it starts to exchange data when the PLC is set to *run* mode.

3.3 Configure the Frequency Converter

3.3.1 Frequency Converter Parameters

The following parameters are important when configuring the frequency converter with a PROFIBUS interface:

- *Parameter 0-40 [Hand on] Key on LCP*. Pressing [Hand on] disables control of the frequency converter via PROFIBUS.
- *Parameter 8-02 Control Word Source*. After an initial power-up, the frequency converter automatically detects whether a fieldbus option is installed in slot A. The frequency converter then sets *parameter 8-02 Control Word Source* to [3] *Option A*. If an option is added to, changed in, or removed from an already commissioned frequency converter, it does not change *parameter 8-02 Control Word Source*. Instead, the frequency converter enters trip mode and shows an error.
- *Parameter 8-10 Control Word Profile*. Select between the Danfoss FC Profile and the PROFIdrive profile.
- *Parameter 8-50 Coasting Select* to *parameter 8-56 Preset Reference Select*. Select how to gate PROFIBUS control commands with digital input command of the control card.
- *Parameter 8-03 Control Word Timeout Time* to *parameter 8-05 End-of-Timeout Function*. Set the reaction in the event of a bus timeout via these parameters.
- *Parameter 9-18 Node Address*.
- *Parameter 8-07 Diagnosis Trigger*.

NOTICE

The setting in *parameter 8-01 Control Site* overrides the settings in *parameter 8-50 Coasting Select* to *parameter 8-56 Preset Reference Select*, and they all act on bus control.



3.3.2 LEDs

The 2 bicolor LEDs in the VLT® PROFIBUS DP MCA 101 indicate the status of PROFIBUS communication.

3

The LED marked NS (FCD 302: NS2) indicates the network status, that is, the cyclic communication to the PROFIBUS master. When this light is a constant green, data exchange between the master and the frequency converter is active.

The LED marked MS (FCD 302: BUS MS) indicates the module status, that is, acyclic DP-V1 communication from either a PROFIBUS master class 1 (PLC) or a master class 2 (MCT 10 Set-up Software, FDT tool). When this light is a constant green, DP-V1 communication from master classes 1 and 2 is active.

For details of the full range of communications status indicated by the LEDs, refer to *chapter 8 Troubleshooting*.

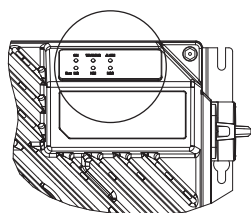

1308C259:10

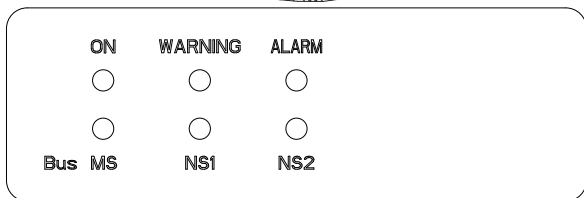

A

Illustration 3.11 FCD 302 LED Panel

4 Control

4.1 PPO Types

The PROFIBUS profile for frequency converters specifies a number of communication objects (parameter process data objects, PPO). The PROFIBUS profile for frequency converters is suitable for data exchange between a process controller (for example PLC) and a frequency converter. All PPOs are defined for cyclic data transfer (DP-V0) for transferring process data (PCD) and parameters (PCA) from the master to the slave, and conversely.

Pure process data objects

PPO types 3, 4, 6, 7, and 8 are pure process data objects for applications requiring no cyclic parameter access. The PLC sends out process control data, and the frequency converter then responds with a PPO of the same length, containing process status data.

Illustration 4.1 shows the available PPO types:

- PCD 1: The first 2 bytes of the process data area (PCD 1) comprise a fixed part present in all PPO types.
- PCD 2: The next 2 bytes are fixed for PCD write entries (see *parameter 9-15 PCD Write Configuration [1]*), but configurable for PCD read entries (see *parameter 9-16 PCD Read Configuration [1]*).
- PCD 3–10: In the remaining bytes, the process data can be parameterized with process signals, see *parameter 9-23 Parameters for Signals*.

The setting in *parameter 9-15 PCD Write Configuration* determines the signals for transmission (request) from the master to the frequency converter.

The setting in *parameter 9-16 PCD Read Configuration* determines the signals for transmission (response) from the frequency converter to the master.

Parameter channel and process data

PPO types 1, 2, and 5 consist of a parameter channel and process data. Use the parameter channel for reading and/or updating of parameters (successively). Alternatively, for better utilization of I/O and PLC capacity, access parameters via DP-V1. To access via DP-V1, select a pure process data object (PPO type 3, 4, 6, 7, or 8).

Select the PPO type in the master configuration. The selection is automatically recorded in the frequency converter. No manual setting of PPO types in the frequency converter is required. Read the current PPO type in *parameter 9-22 Telegram Selection*. The setting *[1] Standard telegram 1* is equivalent to PPO type 3.

In addition, all PPO types can be set up as word-consistent or module-consistent. The process data area can be word- or module-consistent, whereas the parameter channel must always be module-consistent.

- Word-consistent data is transmitted as individual, independent words between the PLC and the frequency converter.
- Module-consistent data is transmitted as sets of interrelated words transferred simultaneously between the PLC and the frequency converter.

Standard telegram

1

CTW/STW	REF/MAV
---------	---------

(The old PPO type 3)

Danfoss telegram

4

PPO 1

PCV	CTW/STW	REF/MAV
-----	---------	---------

PPO 2

PCV	CTW/STW	REF/MAV	PCD 2 Read/ Write	PCD 3 Read/ Write
-----	---------	---------	-------------------------	-------------------------

PPO 3

CTW/STW	REF/MAV
---------	---------

PPO 4

PCV	CTW/STW	REF/MAV	PCD 2 Read/ Write	PCD 3 Read/ Write	PCD 4 Read/ Write	PCD 5 Read/ Write
-----	---------	---------	-------------------------	-------------------------	-------------------------	-------------------------

PPO 6

CTW/STW	REF/MAV	PCD 2 Read/ Write	PCD 3 Read/ Write	PCD 4 Read/ Write	PCD 5 Read/ Write
---------	---------	-------------------------	-------------------------	-------------------------	-------------------------

PPO 7

CTW/STW	REF/MAV	PCD 2 Read/ Write	PCD 3 Read/ Write	PCD 4 Read/ Write	PCD 5 Read/ Write	PCD 6 Read/ Write	PCD 7 Read/ Write
---------	---------	-------------------------	-------------------------	-------------------------	-------------------------	-------------------------	-------------------------

PPO 8

CTW/STW	REF/MAV	PCD 2 Read/ Write	PCD 3 Read/ Write	PCD 4 Read/ Write	PCD 5 Read/ Write	PCD 6 Read/ Write	PCD 7 Read/ Write	PCD 8 Read/ Write	PCD 9 Read/ Write
---------	---------	-------------------------	-------------------------	-------------------------	-------------------------	-------------------------	-------------------------	-------------------------	-------------------------

Illustration 4.1 Available PPO Types

4.2 Process Data

Use the process data part of the PPO to control and monitor the frequency converter via the PROFIBUS.

4.2.1 Process Control Data

Process control data (PCD) is the process data sent from the PLC to the frequency converter.

Master/slave				
1	2	3	10
CTW	MRV	PCD	PCD
PCD write				

Table 4.1 Process Control Data

PCD 1 contains a 16-bit control word, and each bit controls a specific function of the frequency converter, see *chapter 4.3 Control Profile*.

PCD 2 contains a 16-bit speed setpoint in percentage format. See *chapter 4.2.3 Reference Handling*.

The settings in *parameter 9-15 PCD Write Configuration* and *parameter 9-16 PCD Read Configuration* define the content of PCD 3 to PCD 10.

4.2.2 Process Status Data

Process status data is the process data sent from the frequency converter and contains information about the current state.

Slave/master				
1	2	3	10
STW	MAV	PCD	PCD
PCD read				

Table 4.2 Process Status Data

PCD 1 contains a 16-bit status word, and each bit contains information regarding a possible state of the frequency converter.

PCD 2 contains per default the value of the current speed of the frequency converter in percentage format (see *chapter 4.2.3 Reference Handling*). PCD 2 can be configured to contain other process signals.

The settings in *parameter 9-16 PCD Read Configuration* define the content of PCD 3 to PCD 10.

4.2.3 Reference Handling

The reference handling is an advanced mechanism that sums up references from different sources, as shown in *Illustration 4.2*.

For more information on reference handling, refer to the *design guide* of the relevant frequency converter.

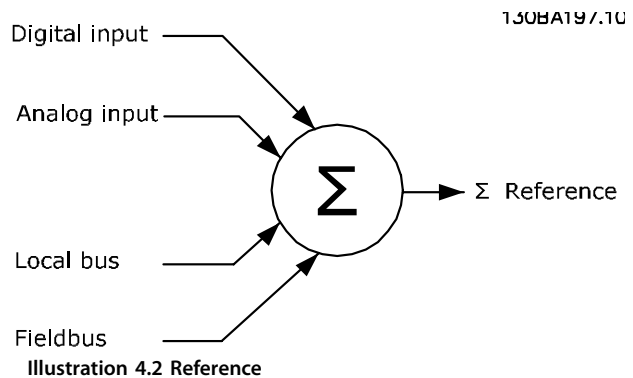

Illustration 4.2 Reference

The reference, or speed setpoint, is sent via PROFIBUS and is always transmitted to the frequency converter in percentage format as integers shown in hexadecimal (0–4000 hex).

The reference (MRV) and feedback (MAV) are always scaled equally. The setting of *parameter 3-00 Reference Range* determines the scaling of the reference and feedback (MAV), see *Illustration 4.3*.

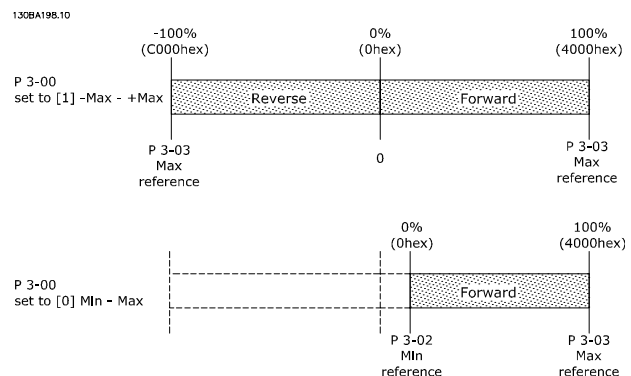

Illustration 4.3 Reference (MRV) and Feedback (MAV), Scaled

NOTICE

When *parameter 3-00 Reference Range* is set to [0] Min - Max, a negative reference is handled as 0%.

The actual output of the frequency converter is limited by the speed limit parameters *Motor Low/High Speed Limit [RPM/Hz]* in *parameter 4-11 Motor Speed Low Limit [RPM]* or *parameter 4-14 Motor Speed High Limit [Hz]*.

The final speed limit is set in *parameter 4-19 Max Output Frequency*.

Table 4.3 lists the reference (MRV) and the feedback (MAV) formats.

MRV/MAV	Integer in hex	Integer in decimal
100%	4000	16384
75%	3000	12288
50%	2000	8192
25%	1000	4096
0%	0	0
-25%	F000	-4096
-50%	E000	-8192
-75%	D000	-12288
-100%	C000	-16384

Table 4.3 Reference/Feedback (MRV/MAV) Format

NOTICE

Negative numbers are formed as complement of 2.

NOTICE

The data type for MRV and MAV is an N2 16-bit standardized value, expressing a range from -200% to +200% (8001 to 7FFF).

Example

The following settings determine the speed, as shown in Table 4.4:

- *Parameter 1-00 Configuration Mode* set to [0] Speed open loop.
- *Parameter 3-00 Reference Range* set to [0] Min-Max.
- *Parameter 3-02 Minimum Reference* set to 100 RPM.
- *Parameter 3-03 Maximum Reference* set to 3000 RPM.

MRV/MAV		Actual speed [RPM]
0%	0 hex	100
25%	1000 hex	825
50%	2000 hex	1550
75%	3000 hex	2275
100%	4000 hex	3000

Table 4.4 Actual Speed for MRV/MAV

4.2.4 Process Control Operation

In process control operation, *parameter 1-00 Configuration Mode* is set to [3] Process.

The reference range in *parameter 3-00 Reference Range* is always [0] Min - Max.

- MRV is the process setpoint.
- MAV expresses the actual process feedback (range ±200%).

4.2.5 Influence of the Digital Input Terminals on FC Control Mode

In *parameter 8-50 Coasting Select* to *parameter 8-56 Preset Reference Select*, set the influence of the digital input terminals on the control of the frequency converter.

NOTICE

The setting of *parameter 8-01 Control Site* overrules the settings in *parameter 8-50 Coasting Select* to *parameter 8-56 Preset Reference Select*. The setting of terminal 37 coast stop (safe) overrules any other parameter.

Program each of the digital input signals to logic AND, logic OR, or to have no relation to the corresponding bit in the control word. In this way, the following signal sources initiate a specific control command, for example stop/coast:

- Fieldbus only.
- Fieldbus AND digital input.
- Either fieldbus OR digital input terminal.

NOTICE

To control the frequency converter via PROFIBUS, set *parameter 8-50 Coasting Select* to either [1] Bus or [2] Logic AND. Then set *parameter 8-01 Control Site* to [0] Digital and ctrl.word or [2] Controlword only.

For more detailed information and examples of logical relationship options, see *chapter 8 Troubleshooting*.

4.3 Control Profile

Control the frequency converter according to:

- The PROFIdrive profile, see *chapter 4.4 PROFIdrive Control Profile*, or
- The Danfoss FC control, see *chapter 4.5 Danfoss FC Control Profile*.

Select the control profile in *parameter 8-10 Control Word Profile*. The choice of profile affects the control word and status word only.

Chapter 4.4 PROFIdrive Control Profile and *chapter 4.5 Danfoss FC Control Profile* provide a detailed description of control and status data.

4.4 PROFIdrive Control Profile

This section describes the functionality of the control word and status word in the PROFIdrive profile.

4.4.1 Control Word According to PROFIdrive Profile (CTW)

The control word is used to send commands from a master (for example a PC) to a slave.

Bit	Bit=0	Bit=1
00	OFF 1	ON 1
01	OFF 2	ON 2
02	OFF 3	ON 3
03	Coasting	No coasting
04	Quick stop	Ramp
05	Hold frequency output	Use ramp
06	Ramp stop	Start
07	No function	Reset
08	Jog 1 OFF	Jog 1 ON
09	Jog 2 OFF	Jog 2 ON
10	Data invalid	Data valid
11	No function	Slow down
12	No function	Catch up
13	Parameter set-up	Selection lsb
14	Parameter set-up	Selection msb
15	No function	Reverse

Table 4.5 Control Word Bits

Explanation of the control bits

Bit 00, OFF 1/ON 1

Normal ramp stops using the ramp times of the actual selected ramp.

Bit 00=0 stops and activates the output relay 1 or 2 if the output frequency is 0 Hz, and if [31] Relay 123 is selected in *parameter 5-40 Function Relay*.

When bit 0=1, the frequency converter is in state 1, Switching on inhibited.

Refer to *Illustration 4.4*.

Bit 01, OFF 2/ON 2

Coast stop.

Bit 01=0 coast stops and activates the output relay 1 or 2 if the output frequency is 0 Hz, and if [31] Relay 123 is selected in *parameter 5-40 Function Relay*.

When bit 01=1, the frequency converter is in state 1, Switching on inhibited. Refer to *Illustration 4.4*.

Bit 02, OFF 3/ON 3

Quick stop using the ramp time of *parameter 3-81 Quick Stop Ramp Time*.

Bit 02=0 quick stops and activates the output relay 1 or 2 if the output frequency is 0 Hz, and if [31] Relay 123 is selected in *parameter 5-40 Function Relay*.

When bit 02=1, the frequency converter is in state 1, Switching on inhibited.

Refer to *Illustration 4.4*.

Bit 03, coasting/no coasting

Bit 03=0 leads to a coast stop.

When bit 03=1, if the other start conditions are fulfilled, the frequency converter can start.

NOTICE

The selection in *parameter 8-50 Coasting Select* determines how bit 03 is linked with the corresponding function of the digital inputs.

Bit 04, quick stop/ramp

Quick stop using the ramp time of *parameter 3-81 Quick Stop Ramp Time*.

When bit 04=0, a quick stop occurs.

When bit 04=1, if the other start conditions are fulfilled, the frequency converter can start.

NOTICE

The selection in *parameter 8-51 Quick Stop Select* determines how bit 04 is linked with the corresponding function of the digital inputs.

Bit 05, hold frequency output/use ramp

When bit 05=0, the present output frequency is maintained, even if the reference value is modified.

When bit 05=1, the frequency converter can perform its regulating function again according to the respective reference value.

Bit 06, ramp stop/start

Normal ramp stop using the ramp times of the actual ramp selected. In addition, if [31] Relay 123 is selected in *parameter 5-40 Function Relay*, and if the output frequency is 0 Hz, this bit activates output relay 01 or 04.

Bit 06=0 stops the frequency converter.

When bit 06=1, if the other start conditions are fulfilled, the frequency converter can start.

NOTICE

The selection in *parameter 8-53 Start Select* determines how bit 06 is linked with the corresponding function of the digital inputs.

Bit 07, no function/reset

Reset after switching off. Acknowledges event in fault buffer.

When bit 07=0, no reset occurs.

When there is a slope change of bit 07 to 1, a reset occurs after switching off.

Bit 08, jog 1 OFF/ON

Activation of the pre-programmed speed in *parameter 8-90 Bus Jog 1 Speed*. JOG 1 is only possible if bit 04=0 and bits 00–03=1.

Bit 09, jog 2 OFF/ON

Activation of the pre-programmed speed in *parameter 8-91 Bus Jog 2 Speed*. JOG 2 is only possible if bit 04=0 and bits 00–03=1.

Bit 10, data invalid/valid

Tells the frequency converter whether to use or ignore the control word.

Bit 10=0 ignores the control word, making it possible to turn off the control word when updating/reading parameters.

Bit 10=1 uses the control word. This function is relevant, because the control word is always contained in the telegram, regardless of which type of telegram is used.

Bit 11, no function/slow down

Used to reduce the speed reference value by the amount given in *parameter 3-12 Catch up/slow Down Value*.

When bit 11=0, no modification of the reference value occurs.

When bit 11=1, the reference value is reduced.

Bit 12, no function/catch up

Used to increase the speed reference value by the amount given in *parameter 3-12 Catch up/slow Down Value*.

When bit 12=0, no modification of the reference value occurs.

When bit 12=1, the reference value is increased.

If both slowing down and accelerating are activated (bits 11 and 12=1), slowing down has priority, and the speed reference value is reduced.

Bits 13/14, set-up selection

Bits 13 and 14 are used to select between the 4 parameter set-ups according to *Table 4.6*.

The function is only possible if [9] *Multi Set-up* has been selected in *parameter 0-10 Active Set-up*. The selection in *parameter 8-55 Set-up Select* determines how bits 13 and 14 are linked with the corresponding function of the digital inputs. Changing set-up while running is only possible if the set-ups have been linked in *parameter 0-12 This Set-up Linked to*.

Set-up	Bit 13	Bit 14
1	0	0
2	1	0
3	0	1
4	1	1

Table 4.6 Parameter Set-ups

Bit 15, no function/reverse

Bit 15=0 causes no reversing.

Bit 15=1 causes reversing.

NOTICE

In the factory setting, reversing is set to [0] *Digital* in *parameter 8-54 Reversing Select*.

NOTICE

Bit 15 causes reversing only when *Ser. communication, Logic or, or Logic and* is selected.

4.4.2 Status Word According to PROFIdrive Profile (STW)

The status word is used to notify a master (for example a PC) about the status of a slave.

Bit	Bit=0	Bit=1
00	Control not ready	Control ready
01	Drive not ready	Drive ready
02	Coasting	Enable
03	No error	Trip
04	OFF 2	ON 2
05	OFF 3	ON 3
06	Start possible	Start not possible
07	No warning	Warning
08	Speed ≠ reference	Speed = reference
09	Local operation	Bus control
10	Out of frequency limit	Frequency limit ok
11	No operation	In operation
12	Drive OK	Stopped, auto start
13	Voltage OK	Voltage exceeded
14	Torque OK	Torque exceeded
15	Timer OK	Timer exceeded

Table 4.7 Status Word Bits

Explanation of the status bits

Bit 00, control not ready/ready

When bit 00=0, bit 00, 01, or 02 of the control word is 0 (OFF 1, OFF 2, or OFF 3) - or the frequency converter is switched off (tripped).

When bit 00=1, the frequency converter control is ready, but power is not necessarily supplied to the unit (in the event of 24 V external supply of the control system).

Bit 01, VLT not ready/ready

Same significance as bit 00, however, power is supplied to the unit. The frequency converter is ready when it receives the necessary start signals.

Bit 02, coasting/enable

When bit 02=0, bit 00, 01, or 02 of the control word is 0 (OFF 1, OFF 2, or OFF 3 or coasting) - or the frequency converter is switched off (trip).

When bit 02=1, bit 00, 01, or 02 of the control word is 1, and the frequency converter has not tripped.

Bit 03, no error/trip

When bit 03=0, no error condition exists in the frequency converter.

When bit 03=1, the frequency converter has tripped and requires a reset signal before it can start.

Bit 04, ON 2/OFF 2

When bit 01 of the control word is 0, bit 04=0.

When bit 01 of the control word is 1, bit 04=1.

Bit 05, ON 3/OFF 3

When bit 02 of the control word is 0, bit 05=0.

When bit 02 of the control word is 1, bit 05=1.

Bit 06, start possible/start not possible

If [1] *PROFdrive* has been selected in *parameter 8-10 Control Word Profile*, bit 06 is 1 after a switch-off acknowledgement, after activation of OFF2 or OFF3, and after switching on the mains voltage. To reset *Start not possible*, set bit 00 of the control word to 0, and bits 01, 02, and 10 to 1.

Bit 07, no warning/warning

Bit 07=0 means that there are no warnings.
Bit 07=1 means that a warning has occurred.

Bit 08, speed≠reference/speed=reference

When bit 08=0, the current speed of the motor deviates from the set speed reference value. The deviation may occur, for example, when the speed is being changed during start/stop through ramp up/down.
When bit 08=1, the current speed of the motor corresponds to the set speed reference value.

Bit 09, local operation/bus control

Bit 09=0 indicates that the frequency converter has been stopped with [Stop] on the LCP, or that [0] *Linked to hand* or [2] *Local* has been selected in *parameter 3-13 Reference Site*.

When bit 09=1, the frequency converter can be controlled through the serial interface.

Bit 10, out of frequency limit/frequency limit OK

When bit 10=0, the output frequency is outside the limits set in *parameter 4-52 Warning Speed Low* and *parameter 4-53 Warning Speed High*.
When bit 10=1, the output frequency is within the indicated limits.

Bit 11, no operation/operation

When bit 11=0, the motor does not turn.
When bit 11=1, the frequency converter has a start signal, or the output frequency is higher than 0 Hz.

Bit 12, drive OK/stopped, auto start

When bit 12=0, there is no temporary overload of the inverter.
When bit 12=1, the frequency converter has stopped due to overload. However, the frequency converter has not switched off (tripped) and starts again after the overload has ended.

Bit 13, voltage OK/voltage exceeded

When bit 13=0, the voltage limits of the frequency converter are not exceeded.
When bit 13=1, the direct voltage in the DC link of the frequency converter is too low or too high.

Bit 14, torque OK/torque exceeded

When bit 14=0, the motor torque is below the limit selected in *parameter 4-16 Torque Limit Motor Mode* and *parameter 4-17 Torque Limit Generator Mode*.
When bit 14=1, the limit selected in *parameter 4-16 Torque Limit Motor Mode* or *parameter 4-17 Torque Limit Generator Mode* is exceeded.

Bit 15, timer OK/timer exceeded

When bit 15=0, the timers for the motor thermal protection and thermal frequency converter protection have not exceeded 100%.
When bit 15=1, a timer has exceeded 100%.

4.4.3 PROFIdrive State Transition Diagram

In the PROFIdrive control profile, the control bits:

- 0–3 perform the basic start-up/power-down functions.
- 4–15 perform application-oriented control.

Illustration 4.4 shows the basic state transition diagram, where control bits 0–3 control the transitions, and the corresponding status bit indicates the actual state. The black bullets indicate the priority of the control signals, where fewer bullets indicate lower priority, and more bullets indicate higher priority.

4

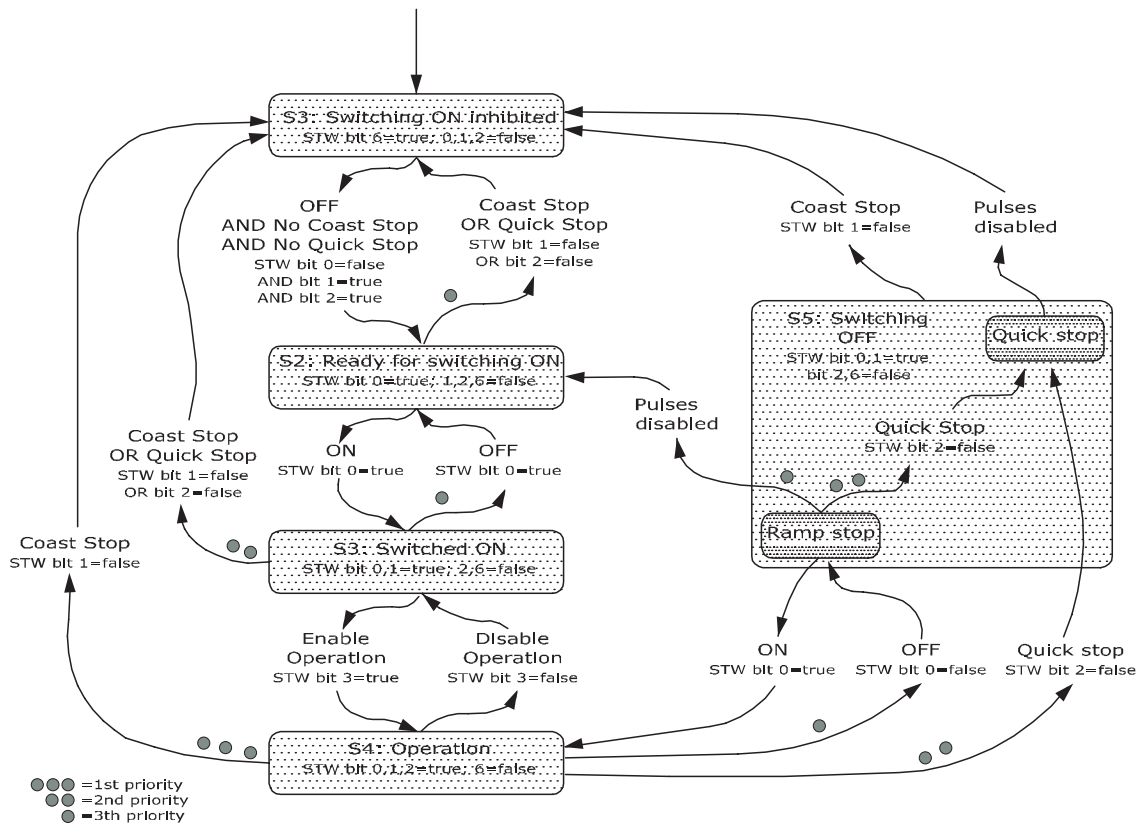

130BD806:10

Illustration 4.4 PROFIdrive State Transition Diagram

4.5 Danfoss FC Control Profile

4.5.1 Control Word According to FC Profile (CTW)

To select Danfoss FC protocol in the control word, set *parameter 8-10 Control Word Profile* to [0] *Frequency converter profile*. Use the control word to send commands from a master (PLC or PC) to a slave (frequency converter).

Bit	Bit value=0	Bit value=1
00	Reference value	External selection lsb
01	Reference value	External selection msb
02	DC brake	Ramp
03	Coasting	No coasting
04	Quick stop	Ramp
05	Hold output frequency	Use ramp
06	Ramp stop	Start
07	No function	Reset
08	No function	Jog
09	Ramp 1	Ramp 2
10	Data invalid	Data valid
11	No function	Relay 01 active
12	No function	Relay 04 active
13	Parameter set-up	Selection lsb
14	Parameter set-up	Selection msb
15	No function	Reverse

Table 4.8 Bit Values for FC Control Word

Explanation of the control bits

Bits 00/01 reference value

Use bits 00 and 01 to select between the 4 reference values, which are pre-programmed in *parameter 3-10 Preset Reference* according to Table 4.9.

NOTICE

In *parameter 8-56 Preset Reference Select*, a selection is made to define how bit 00/01 gates with the corresponding function on the digital inputs.

Bit 01	Bit 00	Programmed reference value	Parameter
0	0	1	[0] <i>Parameter 3-10 Preset Reference</i>
0	1	2	[1] <i>Parameter 3-10 Preset Reference</i>
1	0	3	[2] <i>Parameter 3-10 Preset Reference</i>
1	1	4	[3] <i>Parameter 3-10 Preset Reference</i>

Table 4.9 Programmed Reference Values for Bits

Bit 02, DC brake

Bit 02=0 leads to DC braking and stop. Braking current and duration are set in *parameter 2-01 DC Brake Current* and *parameter 2-02 DC Braking Time*.

Bit 02=1 leads to ramping.

Bit 03, coasting

Bit 03=0 causes the frequency converter immediately to coast the motor to a standstill.

Bit 03=1 enables the frequency converter to start the motor if the other starting conditions have been fulfilled.

NOTICE

In *parameter 8-50 Coasting Select*, a selection is made to define how bit 03 gates with the corresponding function on a digital input.

Bit 04, quick stop

Bit 04=0 quick stops the frequency converter and ramps the motor speed down to stop via *parameter 3-81 Quick Stop Ramp Time*.

Bit 04=1 makes the frequency converter ramp the motor speed down to stop via *parameter 3-42 Ramp 1 Ramp Down Time* or *parameter 3-52 Ramp 2 Ramp Down Time*.

Bit 05, hold output frequency

Bit 05=0 freezes the present output frequency (in Hz). The frozen output frequency can only be changed with the digital inputs (*parameter 5-10 Terminal 18 Digital Input* to *parameter 5-15 Terminal 33 Digital Input*) programmed to [21] *Speed up* and [22] *Speed down*.

Bit 05=1 uses ramp.

NOTICE

If freeze output is active, stop the frequency converter with

- Bit 03 coast stop.
- Bit 02 DC brake.
- Digital input (parameter 5-10 Terminal 18 Digital Input to parameter 5-15 Terminal 33 Digital Input) programmed to DC braking, coasting stop, or reset and coasting stop.

Bit 06, ramp stop/start

Bit 06=0 stops the frequency converter and the motor speed ramps down to stop via the selected ramp-down parameter.

Bit 06=1 allows the frequency converter to start the motor if the other starting conditions have been fulfilled.

NOTICE

In parameter 8-53 Start Select, define how bit 06 ramp stop/start gates with the corresponding function on a digital input.

Bit 07, reset

Bit 07=0 does not cause a reset.

Bit 07=1 resets a trip. Reset is activated on the signal's leading edge, that is, when changing from logic 0 to logic 1.

Bit 08, jog

Bit 08=0, no function.

Bit 08=1, parameter 3-19 Jog Speed [RPM] determines the output frequency.

Bit 09, selection of ramp 1/2

Bit 09=0, ramp 1 is active (parameter 3-40 Ramp 1 Type to parameter 3-47 Ramp 1 S-ramp Ratio at Decel. Start).

Bit 09=1, ramp 2 is active (parameter 3-50 Ramp 2 Type to parameter 3-57 Ramp 2 S-ramp Ratio at Decel. Start).

Bit 10, data not valid/data valid

Tells the frequency converter to use or ignore the control word.

Bit 10=0 ignores the control word.

Bit 10=1 uses the control word. This function is relevant, because the control word is always contained in the telegram, regardless of which type of telegram is used.

Thus, it is possible to turn off the control word, if it is not needed when updating or reading parameters.

Bit 11, relay 01

Bit 11=0, relay 01 is not activated.

Bit 11=1, relay 01 is activated, provided control word bit 11 is selected in parameter 5-40 Function Relay.

Bit 12, relay 04

Bit 12=0, relay 04 is not activated.

Bit 12=1, relay 04 is activated, provided [37] Control word bit 12 is selected in parameter 5-40 Function Relay.

Bit 13/14, selection of set-up

Use bits 13 and 14 to select from the 4 menu set-ups according to Table 4.10:

The function is only possible when [9] Multi Set-ups is selected in parameter 0-10 Active Set-up.

Set-up	Bit 14	Bit 13
1	0	0
2	0	1
3	1	0
4	1	1

Table 4.10 Set-up selection

NOTICE

In parameter 8-55 Set-up Select, define how bit 13/14 gates with the corresponding function on the digital inputs.

Bit 15 reverse

Bit 15=0 means no reversing.

Bit 15=1 means reversing.

4.5.2 Status Word According to FC Profile (STW)

The status word is used to inform the master (for example a PC) of the operating mode of the slave (frequency converter).

Refer to chapter 7 Application Examples for an example of a status word telegram using PPO type 3.

Bit	Bit=0	Bit=1
00	Control not ready	Control ready
01	Frequency converter not ready	Frequency converter ready
02	Coasting	Enable
03	No error	Trip
04	No error	Error (no trip)
05	Reserved	-
06	No error	Trip lock
07	No warning	Warning
08	Speed reference	Speed=reference
09	Local operation	Bus control
10	Out of frequency limit	Frequency limit ok
11	No operation	In operation
12	Frequency converter OK	Stopped, auto start
13	Voltage OK	Voltage exceeded
14	Torque OK	Torque exceeded
15	Timer OK	Timer exceeded

Table 4.11 Definition of Status Bits

Explanation of the status bits**Bit 00, control not ready/ready**

Bit 00=0, the frequency converter has tripped.

Bit 00=1, the frequency converter controls are ready, but the power component is not necessarily receiving any power (in case of 24 V external supply to controls).

Bit 01, frequency converter ready

Bit 01=0, the frequency converter is not ready for operation.

Bit 01=1, the frequency converter is ready for operation, but there is an active coasting command via the digital inputs or via serial communication.

Bit 02, coasting stop

Bit 02=0, the frequency converter has released the motor.

Bit 02=1, the frequency converter can start the motor when a start command is given.

Bit 03, no error/trip

Bit 03=0, the frequency converter is not in fault mode.

Bit 03=1, the frequency converter is tripped, and a reset signal is required to re-establish operation.

Bit 04, no error/error (no trip)

Bit 04=0, the frequency converter is not in fault mode.

Bit 04=1, there is a frequency converter error but no trip.

Bit 05, not used

Bit 05 is not used in the status word.

Bit 06, no error/triplock

Bit 06=0, the frequency converter is not in fault mode.

Bit 06=1, the frequency converter is tripped and locked.

Bit 07, no warning/warning

Bit 07=0, there are no warnings.

Bit 07=1, a warning has occurred.

Bit 08, speed reference/speed = reference

Bit 08=0, the motor runs, but the present speed is different from the preset speed reference. It could, for example, be the case while the speed ramps up/down during start/stop.

Bit 08=1, the present motor speed matches the preset speed reference.

Bit 09, local operation/bus control

Bit 09=0, [Stop/Reset] is pressed on the LCP, or [2] Local is selected in *parameter 3-13 Reference Site*. It is not possible to control the frequency converter via serial communication.

Bit 09=1, it is possible to control the frequency converter via the fieldbus/serial communication.

Bit 10, out of frequency limit

Bit 10=0, the output frequency has reached the value in *parameter 4-11 Motor Speed Low Limit [RPM]* or *parameter 4-13 Motor Speed High Limit [RPM]*.

Bit 10=1, the output frequency is within the defined limits.

Bit 11, no operation/in operation

Bit 11=0, the motor does not run.

Bit 11=1, the frequency converter has a start signal or the output frequency is higher than 0 Hz.

Bit 12, frequency converter OK/stopped, auto start

Bit 12=0, there is no temporary overtemperature in the frequency converter.

Bit 12=1, the frequency converter has stopped because of overtemperature, but it has not tripped and resumes operation once the overtemperature stops.

Bit 13, voltage OK/limit exceeded

Bit 13=0, there are no voltage warnings.

Bit 13=1, the DC voltage in the frequency converter's DC link is too low or too high.

Bit 14, torque OK/limit exceeded

Bit 14=0, the motor current is lower than the torque limit selected in *parameter 4-16 Torque Limit Motor Mode* or *parameter 4-17 Torque Limit Generator Mode*.

Bit 14=1, the torque limits in *parameter 4-16 Torque Limit Motor Mode* and *parameter 4-17 Torque Limit Generator Mode* are exceeded.

Bit 15, timer OK/limit exceeded

Bit 15=0, the timers for motor thermal protection and frequency converter thermal protection have not exceeded 100%.

Bit 15=1, 1 of the timers has exceeded 100%.

4.6 Synchronize and Freeze

The control commands sync/unsync and freeze/unfreeze are broadcast functions.

Use sync/unsync to synchronize control commands and/or speed reference to all the connected frequency converters.

Use freeze/unfreeze to freeze the status feedback in the slaves to obtain synchronized feedback from all connected slaves.

The synchronize and freeze commands affect only process data (the PCD part of the PPO).

4.6.1 Sync/Unsync

To obtain simultaneous reactions such as synchronized start, stop, or speed change in several slaves, use sync/unsync.

A sync command freezes the relevant control word and speed reference. Incoming process data are stored, but not used, until a new sync command or an unsync command is received.

An unsync command stops the synchronization mechanism and enables normal DP data exchange.

4.6.2 Freeze/Unfreeze

Freeze/unfreeze can be used for simultaneous reading of process data, for example output current, from several slaves.

A freeze command freezes the actual values and upon request the slave sends back the value that was present when the freeze command was received.

At the receipt of an unfreeze command, the values once again are continuously updated and the slave returns a present value, for example a value generated by current conditions.

The values are updated when a new freeze or unfreeze command is received.

5 Parameter Access

5.1 Parameter Access in General

In an automated system, frequency converter parameters can be accessed either from the process controller (that is, PLC), or from various kinds of HMI equipment.

Parameter access from controllers and HMI

Parameters are located in 4 separate set-ups. Parameter access in the frequency converter is performed via several separated parameter channels. Use the separated channels individually to access a certain parameter set-up. Select the wanted set-up in *parameter 0-11 Edit Set-up* or *parameter 9-70 Edit Set-up*.

Using the above-mentioned mechanism allows reading or writing to and from parameters in a certain set-up from a master class 1, for example a PLC. It is also possible to access parameters simultaneously in a different set-up from a master class 2, for example a PC tool, without interfering with the set-up selection for the programming sources.

Parameters can be accessed via:

- LCP.
- FC Protocol on RS485 or USB.
- Cyclic data access on DP-V0 (PCV Channel).
- PROFIBUS master class 1.
- PROFIBUS master class 2 (3 connections possible).

NOTICE

Although the parameter channels are separated, data conflict can occur when writing to parameters from an HMI unit into a set-up actively in use by the frequency converter or the process controller (for example a PLC).

5.1.1 Data Store

Parameters write via the PCV channel (DP V0) is stored in RAM only. If data has to be stored in non-volatile memory, use *parameter 9-71 Profibus Save Data Values* for storing 1 or more set-ups.

Using DP-V1 access, store parameters either in RAM or non-volatile memory by selecting a specific write-request command. At any time, store non-stored data in non-volatile memory by activating *parameter 9-71 Profibus Save Data Values*.

5.1.2 Read/Write in Double Word Format

The special request IDs 0X51 (read) and 0X52 (write) allow reading and writing to all parameters containing numeric values in a general format of double word. The value element must be right-aligned and unused MSBs filled with zeros.

Example: Read of a parameter of type U8 is transmitted as 00 00 00 xx, where xx is the value to be transmitted. The data type signaled by the telegram is 43h (dword).

5.1.3 PROFIBUS DP-V1

The acyclic DP-V1 transmission allows reading and writing parameter values, as well as reading a number of descriptive attributes for each parameter. Access to parameters via DP-V1 is described in *chapter 5.2 DP-V1 Parameter Access*.

5.1.4 PROFIBUS DP V0/PCV Channel

Parameter access via the PCV channel is performed using PROFIBUS DP V0 cyclic data exchange, where the PCV channel is part of the PPOs described in *chapter 4.1 PPO Types*. Using the PCV channel, it is possible to read and write parameter values, as well as read a number of descriptive attributes for each parameter. The functionality of the PCV channel is described in *chapter 5.3 PCV Parameter Access*.

NOTICE

Object and data types common to both DP-V1 and PCV parameter access are listed in *chapter 5 Parameter Access*.

5.2 DP-V1 Parameter Access

This section is useful for the developer with some experience in:

- PLC programs with PROFIBUS master class 1 functionality.
- PC applications with PROFIBUS master class 2 functionality.

For more detailed instructions in use of the DP-V1 function, refer to the PROFIBUS master manual from the PLC supplier.

5.2.1 PROFIBUS DP-V1 Introduction

The PROFIBUS DP extension DP-V1 offers acyclic communication in addition to the cyclic data communication of DP V0. This feature is possible using a DP master class 1 (for example, PLC), as well as a DP master class 2 (for example PC Tool).

Cyclic communication means that data transfer takes place continuously with a certain refresh rate. This function is the known DP V0 function normally used for quick updates of I/O process data.

Acyclic communication is a one-off data transfer event, used for read/write from and to parameters from process controllers, PC-based tools, or monitoring systems.

5.2.2 Features of a Master Class 1 Connection

- Cyclic data exchange (DP-V0).
- Acyclic read/write from and to parameters.

A master class 1 is used as the process controller (either PLC or PC-based), responsible for commands, speed reference, status of the application, and so on. The master class 1 acyclic connection can be used for general parameter access in the slaves. However, the acyclic connection is fixed and cannot be changed during operation.

5.2.3 Features of a Master Class 2 Connection

- Initiate/abort acyclic connection.
- Acyclic read/write from and to parameters.

The master class 2 acyclic connection is typically used for configuration or commissioning tools for easy access to each parameter in any slave in the system. The acyclic connection can be dynamically established (initiated) or removed (aborted) even when a master class 1 is active on the network.

5.2.4 Services Overview

Master type	Service					
	Read	Write	Data transport	Initiate	Abort	Alarm
	Read data from slave	Write data to slave	Read and write data	Open a connection	Close a connection	
Master class 1	Yes	Yes	Yes	-	-	-
Master class 2	Yes	Yes	Yes	Yes	Yes	-

Table 5.1 Services Overview

5.2.5 Principle of Data Exchange by PROFIBUS DP-V1

In a DP cycle, the master class 1 (MC1) first updates the cyclic process data for all slaves in the system. The MC1 then sends 1 acyclic message to 1 slave. If a master class 2 (MC2) is connected, the MC1 hands over the bus rights to MC2. MC2 is then allowed to send 1 acyclic message to 1 slave. The token is then handed back to the MC1, and a new DP cycle begins.

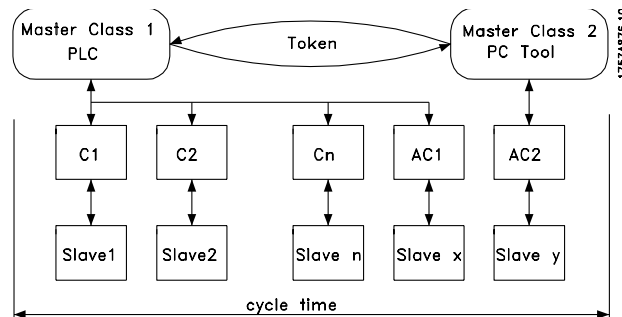

Illustration 5.1 DP Cycle

- MC: Master class.
- C1...Cn: Cyclic data.
- AC1: Acyclic data master class 1.
- AC2: Acyclic data master class 2.

PROFIBUS DP services are activated via specific service access points (SAP). Table 5.2 shows the SAP specified for acyclic communication.

Master SAP	Slave SAP	Description
50 (32H)	49 (31H)	Master Class 2: Initiate request
50 (32H)	0..48 (0..30H)	Master Class 2: Abort, read, write, data transfer
51 (33H)	50, 51 (32H, 33H)	Master Class 2: Alarm
51 (33H)	51 (33H)	Master Class 2: Read, write

Table 5.2 Service Access Points (SAP)

5.2.6 DP-V1 Features for Parameter Access

This section describes how to use DP-V1 for accessing frequency converter parameters.

The standard PROFIBUS DP-V1 read and write services are not sufficient for accessing the many parameters and attributes in the frequency converter. For this reason, the PROFIdrive parameter channel is defined. Using this parameter read/write is performed by addressing a single DP-V1 object in the frequency converter as shown in the example, Table 5.3.

For a detailed description of the DP-V1 command handling, refer to the *PROFIBUS DP-V1 Design Guide*.

Example

Slot=0
Index=47

PROFIBUS telegram header	Data unit						PROFIBUS telegram trailer
	DP-V1 command/response				PROFIdrive V3.0 parameter channel		
DU 0	DU 1	DU 2	DU 3	Req./Res. Header	Data		

Table 5.3 General Structure for Telegram

Use the DP-V1 command/response part for the standard DP-V1 read/write on slot 0, index 47 data block.

Use the PROFIdrive V3 parameter channel to access specific parameter data in the frequency converter.

5.2.7 DP-V1 Read/Write Services

Table 5.4 shows the content of the DP-V1 command/response headers and their possible attributes.

DU byte	Value	Meaning	Specified
0	Function number 0x48	Idle REQ, RES	-
	0x51	Data transport REQ, RES	-
	0x56	Resource manager REQ	-
	0x57	Initiate REQ, RES	-
	0x58	Abort REQ	-
	0x5C	Alarm REQ, RES	-
	0x5E	Read REQ, RES	-
	0x5F	Write REQ, RES	-
	0xD1	Data transport negative response	-
	0xD7	Initiate negative response	-
	0xDC	Alarm negative response	-
	0xDE	Read negative response	-
0xDF	Write negative response	-	
1	Always zero	Slot number	DP-V1
2	47	Index	DP-V1
3	xx	Data length	DP-V1
4..n		User data	PNO drive profile V3.0

Table 5.4 DP-V1 Command/Response Headers

5.2.8 DP-V1 Acyclic Parameter Channel

Use the PROFIdrive parameter channel for read and write access to parameter values and attributes.

- Parameter values of simple variable, array, and visible string.
- Parameter description elements such as type and minimum/maximum value.
- Descriptive text for parameter values.
- Access to multiple parameters in 1 telegram is also possible.

Table 5.5 shows the structure of the PROFIdrive parameter channel.

PROFIBUS DP-V1 telegram for read/write from or to a frequency converter parameter:

PROFIBUS telegram header	Data unit							PROFIBUS telegram trailer
	DP-V1 command/response				PROFdrive V3.0 parameter channel			
	DU 0	DU 1	DU 2	DU 3	Req./Res. Header	Data		

Table 5.5 Structure of the PROFdrive Parameter Channel

Table 5.6 shows the principle structure of the PROFdrive parameter channel.

The DP-V1 parameter request telegram consists of 3 data blocks:

- A request header, which defines the request (read or write), and the number of parameters to access. The master sets the request reference, and uses this information to evaluate the response.
- An address field where all addressing attributes of the wanted parameters are defined.
- A data field where all parameter data values is placed.

DP-V1	Parameter request	Byte number
Request header	Request reference	0
	Request ID	1
	Axis	2
Address field	Number of parameters	3
	Attribute	4
	Number of elements	5
	Parameter number	6
		7
	Sub index	8
		9
	n'th parameter number	4+6*(n-1)
		...
Data field	Data format	4+6*n
	Number of values	(4+6*n)+1
	Values	(4+6*n)+2
	n'th data value	...

Table 5.6 Principle Structure of the PROFdrive Parameter Channel

The DP-V1 parameter response telegram consists of 2 data blocks:

- A response header, which indicates:
 - If the request is performed without errors (response ID).
 - The number of parameters.
 - The request reference set by the master within the corresponding request.
- A data field, where the requested data are placed. If 1 or more internal requests have failed, a fault code is placed instead of the data values.

DP-V1	Parameter response	Byte number
Response header	Request reference mirrored	0
	Response ID	1
	Axis mirrored	2
Parameter values	Number of parameters	3
	Format	4
	Number of values	5
	Values of error values	6
	n'th parameter value	...

Table 5.7 DP-V1 Parameter Response Telegram

As the response telegram does not include parameter addressing information, the master must identify the structure of the response data from the request telegram.

5.2.9 Request/Response Attributes

Table 5.8 contains an overview of the possible attributes of the PROFdrive parameter channel.

Field	Data type ¹⁾	Values	Remark	
Request reference	U8	0x01–0xFF	–	
Request ID	U8	0x01	Request parameter value	Identification of read or write request
		0x02	Change parameter value	
		0x42	Change parameter non-volatile	
		0x51	Request parameter value double word	
		0x52	Change parameter value double word	

Field	Data type ¹⁾	Values	Remark	
Response ID	U8	0x01	Request parameter (+) Positive	Identification of the response
		0x02	Change parameter (+) Positive	
		0x81	Request parameter (-) Negative	
		0x82	Change parameter (-) Negative	
Axis	U8	0x00–0xFF	Number (always 0)	–
Number of parameters	U8	0x01–0x25	–	Limitation: DP-V1 telegram length
Attribute	U8	0x10	Value	–
		0x20	Description	Data description
		0x30	Text	–
Number of elements	U8	0x01–0xFA	Quantity 1–234	Limitation: DP-V1 telegram length
Parameter number	U16	0x0001...	Number 1–65535	Parameter number
		0xFFFF	–	–
Subindex	U16	0x0000	Number 0–65535	Array pointer
		0xFFFF	–	–
Format	U8	See Table 5.12		–
Number of values	U8	0x01–0xEA	Quantity 0–234	Limitation: DP-V1 telegram length
Error number	U16	0x0000...	Error number	–

Table 5.8 Overview: Possible Attributes of the PROFIdrive Parameter Channel

1) U8 - Unsigned8, U16 - Unsigned16

5.2.10 Request Reference

Unique identification of request/response pair for the master. The master changes the request reference with each new request. The slave mirrors the request reference in the response.

5.2.11 Request ID

0x01	Request parameter.
0x02	Change parameter (data is NOT stored in non-volatile memory, lost at power cycle).
0x42	Change parameter non-volatile (data is stored in non-volatile memory).
0x51	Request parameter value double word. All parameters are formatted and transferred as double word size, regardless of the actual data type.
0x52	Change parameter value double word. All parameters must be formatted and sent as double word size, regardless of data type.

Table 5.9 Defined Request Identification

5.2.12 Response ID

The response ID indicates if the read or write request was successfully performed in the frequency converter. If the response is negative, the request is answered as negative (first bit=1), and a fault code is entered per partial response instead of the value.

5.2.13 Axis

Set the axis attribute to 0.

5.2.14 Number of Parameters

For multi-parameter requests that specify the number of the parameter address and/or parameter value areas. For a single request, the number is 1.

5.2.15 Attribute

The attribute determines which data to access. The frequency converter responds to the attributes value (10 H), description (20 H), and text (30 H).

5.2.16 Attribute Value (10 H)

The attribute value allows reading or writing of parameter values.

5.2.17 Attribute Description (20 H)

The attribute description allows access to the parameter description. It is possible to read out 1 single description element, or all elements for 1 parameter in 1 telegram. Table 5.10 provides an overview of the existing parameter description, which exists for each parameter in the frequency converter.

Subindex	Description	Data type
1	Identifier ID	V2
2	Number of array elements or length or string	U16
3	Standardization factor	Float
4	Variable attribute	Octet string 2
5	Reserved	Octet string 4
6	Name	Visible string 16
7	Lower limit	Octet string 4
8	Upper limit	Octet string 4
9	Reserved	Octet string 2
10	ID extension	V2
11	PCD reference parameter	U16
12	PCD normalization	V2
0	Complete description	Octet string 46

Table 5.10 Parameter Description Elements (all Elements are Read-only)

Table 5.11 explains each description element.

Identifier ID

Bit	Description
15	Reserved.
14	Array.
13	Parameter value can be reset only.
12	Parameter has been changed from factory setting.
11	Reserved.
10	Additional text array available.
9	Parameter is read-only.
8	Standardization factor and variable attribute not relevant.
0-7	Data type.

Table 5.11 Extra Characteristics of a Parameter

Number of array elements

- Contains the number of array elements, if the parameter is an array.
- Contains the string length, if the parameter value is a string.
- Contains a 0 if the parameter is neither.

Standardization factor

Conversion factor for scaling a given parameter value to standard SI units.

For example, if the given value is in mV, the standardization factor is 1000, which converts the given value to V. The standardization factor is in float format.

Variable attribute

Consists of 2 bytes. The first byte contains the variable index, which defines the physical unit of the parameter (for example A, V).

The second byte is the conversion index, which is a scaling factor for the parameter. All parameters accessible by PROFIBUS are organized and transmitted as real numbers. The conversion index defines a factor for conversion of the actual value to a standard physical unit. A conversion index of -1 means that the actual value must be divided by 10 to become a standard physical unit, for example V.

Name

Contains the parameter name, limited to 16 characters, for example language for *parameter 0-01 Language*. This text is available in the language selected in *parameter 0-01 Language*.

Lower limit

Contains the minimum value of the parameter. Format is 32 bit signed.

Upper limit

Contains the maximum value of the parameter. Format is 32 bit signed.

ID extension

Not supported.

PCD reference parameter

Process data may be scaled by a parameter, for example the maximum reference of 0x4000 (in %) depends on the setting of parameter X.

To enable the master to calculate the real value of the process data, it has to know the value of parameter X. Therefore the process data must deliver a reference to parameter X.

Field PCD normalization

The field PCD normalization must express the value that shows the 100%. Thus, the normalization delivered back must be the set bit 15 and a value of 0xe (14, 2¹⁴ = 0x4000), and the result must be 0x800e.

Complete description

Returns the complete parameter description with the fields 1-12 in order. Length=46 byte.

5.2.18 Attribute Text (30 H)

For some frequency converter parameters, a descriptive text is available, which can be read using this attribute. A bit set in the identifier (ID) parameter description element indicates the availability of a text description for a parameter. The description element can be read out by the

description attribute (20 H) subindex=1. If bit 10 is set, a descriptive text exists for each value of the parameter. As an example, *parameter 0-01 Language* has settings 0–5. For each of these values, a specific text exists: 0=English, 2=Deutsch, and so on.

5.2.19 Format

Specifies the format type for each parameter (word, byte, and so on), see *Table 5.12*.

5.2.20 Supported Data types

Value	Data type
3	Integer16
4	Integer32
5	Unsigned8
6	Unsigned16
7	Unsigned32
9	Visible string
10	Octet string (byte string)
33	N2 (standardised value)
35	V2 (bit sequence)
44	Error
54	Time difference without date indication

Table 5.12 Supported Data Types

5.2.21 Value

The value field contains the parameter value of the request. When the response is negative, the field contains a corresponding fault code. If the values consist of an odd number of bytes, a 0-byte is appended to maintain the word structure of the telegrams.

For a positive partial response, the parameter value field contains the following attributes:

- Format = Data type or byte, word, double word.
- Number of values = Actual number of values.
- Value = Parameter value.

For a negative partial response, the parameter value field contains the following:

- Format = Error (44H).
- Number of values = 1.
- Value = Error value = Error number.

5.2.22 Fault Codes for Drive Profile V 3.0

When the parameter request is invalid, the frequency converter returns a corresponding fault code. *Table 5.13* lists the full range of fault codes.

Fault code	Description	More Info
0x00	Unknown parameter.	0
0x01	Parameter is read-only.	Subindex
0x02	Value out of range due to maximum/minimum value.	Subindex
0x03	Wrong subindex.	Subindex
0x04	Parameter is no array.	0
0x05	Wrong data type (wrong data length).	0
0x06	This parameter may not be set, only reset.	Subindex
0x07	Descriptive element is read-only.	Subindex
0x09	No description available (only value).	0
0x0b	Process control not possible.	0
0x0f	No text array available (only value).	0
0x11	Not possible in current state.	0
0x14	Value out of range due to frequency converter state/configuration.	Subindex
0x15	Reply too long (more than 240 bytes).	0
0x16	Wrong parameter address (unknown or unsupported value for attribute, element, parameter number, or subindex, or illegal combination).	0
0x17	Illegal format (for writing).	0
0x18	Value amount not consistent.	0
0x65	Wrong axis: Action not possible with this axis.	–
0x66	Unknown service request.	–
0x67	This service is not possible with multi-parameter access.	–
0x68	Parameter value cannot be read from bus.	–

Table 5.13 Fault Codes for DP-V1 Parameter Requests

5.3 PCV Parameter Access

The PROFINET cyclic data exchange performs parameter access via the PCV channel. The PCV channel forms part of the PPOs described in *chapter 4 Control*.

Use the PCV channel to read and write parameter values, and read status for descriptive attributes of each parameter.

5.3.1 PCA Handling

The PCA part of PPO types 1, 2, and 5 performs several tasks. Using PCA, the master controls and supervises parameters and requests a response from the slave. Then the slave responds to a request from the master. Requests and responses are a handshake procedure and cannot be

batched. Therefore, when the master sends out a read/write request, it must wait for the response before it sends a new request. The request or response data value is limited to maximum 4 bytes (see RC characteristics in *Table 5.14*), which implies that text strings are not transferable. For further information, see *chapter 7 Application Examples*.

5.3.2 PCA - Parameter Characteristics

15	14	13	12	11	10	9	8	7	6	5	4	3	2	1	0
RC				SMP		PNU									

Table 5.14 PCA - Parameter Characteristics

- RC: Request/response characteristics (range 0–15).
- SMP: Spontaneous message (not supported).
- PNU: Parameter no. (range 1–1999).

5.3.3 Request/Response Handling

The RC portion of the PCA word defines:

- The requests issued from the master to the slave.
- Other portions of the PCV involved:
 - PVA: The PVA portion transmits word-size parameter values in bytes 7 and 8, while long word size values require bytes 5–8 (32 bits).
 - IND: When the response/request contains array elements, the IND carries the array subindex. When parameter descriptions are involved, the IND holds the record subindex of the parameter description.

5.3.4 RC Content

Request

The content of the RC portion of the PCA word for a request is listed in *Table 5.15*.

Request	Function
0	No request.
1	Request parameter value.
2	Change parameter value (word).
3	Change parameter value (long word).
4	Request description element.
5	Change description element.
6	Request parameter value (array).
7	Change parameter value (array word).
8	Change parameter value (array long word).
9	Request number of array elements.
10–15	Not used.

Table 5.15 Request

Response

When the slave rejects a request from the master, the RC word in the PPO-read indicates the rejection by assuming the value 7. Bytes 7 and 8 in the PVA element carry the fault number.

The content of the RC portion of the PCA word for a response is listed in *Table 5.16*.

Response	Function
0	No response.
1	Transfer parameter value (word).
2	Transfer parameter value (long word).
3	Transfer description element.
4	Transfer parameter value (array word).
5	Transfer parameter value (array long word).
6	Transfer number of array elements.
7	Request rejected (including fault number, see <i>Table 5.17</i>).
8	Not serviceable by PCV interface.
9	Not used.
10	Not used.
11	Not used.
12	Not used.
13–15	Not used.

Table 5.16 Response

Fault number	Interpretation
0	Illegal PNU.
1	Parameter value cannot be changed.
2	Upper or lower limit exceeded.
3	Subindex corrupted.
4	No array.
5	Data type false.
6	Cannot be set by user (reset only).
7	Description element cannot be changed.
8	IR required PPO-write not available.
9	Description data not available.
10	Access group.
11	No parameter write access.
12	Key word missing.
13	Text in cyclic transmission not readable.
14	Name in cyclic transmission not readable.
15	Text array not available.
16	PPO-write missing.
17	Request temporarily rejected.
18	Other fault.
19	Data in cyclic transmission not readable.
130	There is no bus access to the parameter called.
131	Data change is not possible because factory set-up is selected.

Table 5.17 Fault Numbers

5.3.5 Example

This example shows

- How to use PPO type 1 to change the ramp-up time to 10 s in *parameter 3-41 Ramp 1 Ramp Up Time*.
- How to command a start and speed reference of 50%.

Frequency converter parameter settings:

- *Parameter 8-50 Coasting Select: [1] Bus.*
Parameter 8-10 Control Word Profile: [1] PROFIdrive profile.

5.3.5.1 PCV

PCA parameter characteristics

PCA part (byte 1–2).

The RC part tells what the PCV part must be used for. The functions available are listed in *chapter 5.3.1 PCA Handling*.

When a parameter is changed, select value 2 or 3. In this example, 3 is selected because *parameter 3-41 Ramp 1 Ramp Up Time* covers a long word (32 bits).

Parameter 3-41 Ramp 1 Ramp Up Time = 155 hex: In this example, bytes 1 and 2 are set to 3155. See the values for bytes 1 and 2 in *chapter 5.3.5 Example*.

IND (bytes 3–4)

Used when reading/changing parameters with subindex, for example *parameter 9-15 PCD Write Configuration*. In the example, bytes 3 and 4 are set to 00 hex. See the values for bytes 3 and 4 in *chapter 5.3.5 Example*.

PVA (bytes 5–8)

Change the data value of *parameter 3-41 Ramp 1 Ramp Up Time* to 10.00 s. The value transmitted must be 1000, because the conversion index for *parameter 3-41 Ramp 1 Ramp Up Time* is 2. Therefore, the value received by the frequency converter is divided by 100, such that the frequency converter perceives 1000 as 10.00. Bytes 5–8 = 1000 = 03E8 hex. See *chapter 5.4 PROFIBUS DP Parameter and Data Type*. See the values for bytes 5–8 in *chapter 5.3.5 Example*.

5.3.5.2 PCD

Control word (CTW) according to PROFIdrive profile:

Control words consist of 16 bits. The meaning of each bit is explained in *chapter 4.4.1 Control Word According to PROFIdrive Profile (CTW)* and *chapter 4.4.2 Status Word According to PROFIdrive Profile (STW)*. The following bit pattern sets all necessary start commands:

0000 0100 0111 1111=047F hex.¹⁾

0000 0100 0111 1110=047E hex.¹⁾

0000 0100 0111 1111=047F hex.

1) For restart after power-up:

- Set bits 1 and 2 of the CTW to 1.
- Toggle bit 0 0–1.

These values are for bytes 9 and 10 in *chapter 5.3.5 Example*.

Quick stop: 0000 0100 0110 1111=046F hex.

Stop: 0000 0100 0011 1111=043F hex.

5.4 PROFIBUS DP Parameter and Data Type

5.4.1 Parameter Description

PROFIBUS DP has a number of description attributes. Read/write on parameter description is performed in the PCV part using the RC commands 4 and 5, and the subindex of the wanted description element.

5.4.2 Size Attribute

Find the size index and the conversion index for each parameter from the parameter list in the respective *operating instructions*. See also size and conversion indices in *Table 5.18*.

Physical quantity	Size index	SI unit name	SI unit symbol	Conversion index	Conversion factor
	0	No dimension			
Time	4	Second	s	0	1
		Millisecond	ms	-1	0.1
		Minute	min	-2	0.01
		Hour	h	-3	0.001
		Day	d	70	60
Energy	8	Watt hour	Wh	74	3600
		Kilowatt hour	kWh	77	86400
		Megawatt hour	MWh	0	1
Power	9	Milliwatt	mW	3	1000
		Watt	W	6	10 ⁶
		Kilowatt	kW	-3	0.001
		Megawatt	MW	0	1
Rotation	11	Rotation per minute	RPM	3	1000
Torque	16	Newton meter	Nm	0	1
		Kilo newton meter	kNm	3	1000
Temperature	17	Degree celsius	°C	0	1
Voltage	21	Millivolt	mV	-3	0.001
		Volt	V	0	1
		Kilovolt	kV	3	1000
Current	22	Milliampere	mA	-3	0.001
		Ampere	A	0	1
		Kilo ampere	kA	3	1000
Resistance	23	Milliohm	mΩ	-3	0.001
		Ohm	Ω	0	1
		Kiloohm	kΩ	3	1000
Ratio	24	Percent	%	0	1
Relative change	27	Percent	%	0	1
Frequency	28	Hertz	Hz	0	1
		Kilohertz	kHz	3	1000
		Megahertz	MHz	6	10 ⁶
		Gigahertz	GHz	9	10 ⁹

Table 5.18 Size Index and Conversion Index

5.4.3 Object and Data Types Supported

Data type	Short name	Description
3	I2	Integer 16
4	I4	Integer 32
5	-	Unsigned 8
6	O2	Unsigned 16
7	O4	Unsigned 32
9	-	Visible string
10	-	Byte string
33	N2	Standardized value (16 bit)
35	V2	Bit sequence
54	-	Time difference without date indication

Table 5.19 Supported Data Types

5.4.4 Standardized Value

The frequency reference value transmits to the frequency converter in the form of a 16-bit word. The value transmits in integers (0–32767). The value 16384 (4000 hex) corresponds to 100%. Negative numbers are formed with the aid of the 2s complement.
 0%=0 (0h), 100%=2¹⁴ (4000 h)

Data type	N2
Range	-200% to +200%
Resolution	2 ⁻¹⁴ =0.0061%
Length	2 bytes

Table 5.20 N2 Data Type

Msb is the first bit after the sign bit in the first byte.

- Sign bit = 0 = positive number.
- Sign bit = 1 = negative number.

Bit	Byte 1	Byte 2
8	SIGN	2 ⁷
7	2 ¹⁴	2 ⁶
6	2 ¹³	2 ⁵
5	2 ¹²	2 ⁴
4	2 ¹¹	2 ³
3	2 ¹⁰	2 ²
2	2 ⁹	2 ¹
1	2	2 ⁰

Table 5.21 Notation is 2s Complement

Bit sequence

16 boolean values for control and presentation of user functions.

Bit	Byte 1	Byte 2
8	15	7
7	14	6
6	13	5
5	12	4
4	11	3
3	10	2
2	9	1
1	8	0

Table 5.22 Notation is Binary

6 Parameters

6.1 8-** PROFIBUS Parameters

This chapter describes the general parameters relating to PROFIBUS and the communication settings of the frequency converter.

Not all product series support all parameters, just as the parameter settings may vary between the product series. For details of the parameters in parameter groups 8-** *Comm. and Options*, 9-** *PROFIBUS*, and 16-** *Data Readouts*, refer to the *programming guide* of the specific product series.

6

8-01 Control Site		
Option:	Function:	
	The setting in this parameter overrides the settings in <i>parameter 8-50 Coasting Select</i> to <i>parameter 8-56 Preset Reference Select</i> .	
[0]	Digital and ctrl.word	Control by using both digital input and control word.
[1]	Digital only	Control by using digital inputs only.
[2]	Controlword only	Control by using control word only.

8-02 Control Word Source		
Option:	Function:	
	<p>NOTICE</p> <p>This parameter cannot be adjusted while the motor is running.</p> <p>Select the source of the control word: 1 of 2 serial interfaces or 4 installed options. During initial power-up, the frequency converter automatically sets this parameter to [3] Option A if it detects a valid fieldbus option installed in slot A. When the option is removed, the frequency converter detects a configuration change, sets <i>parameter 8-02 Control Word Source</i> to default setting [1] FC RS485, and trips. If an option is installed after initial power-up, the setting of <i>parameter 8-02 Control Word Source</i> does not change, but the frequency converter trips and shows: <i>Alarm 67, Option Changed</i>. When retrofitting a bus option into a frequency converter that did not have a bus option installed earlier, change the control to bus-based. This change is required for safety reasons to avoid an unintended change.</p>	
[0]	None	
[1]	FC RS485	
[2]	FC USB	

8-02 Control Word Source		
Option:	Function:	
[3]	Option A	
[4]	Option B	
[5]	Option C0	
[6]	Option C1	
[30]	External Can	

8-03 Control Word Timeout Time		
Range:	Function:	
1 s*	[0.1 - 18000 s]	Enter the maximum time expected to pass between the reception of 2 consecutive telegrams. If this time is exceeded, it indicates that the telegram communication has stopped. The function selected in <i>parameter 8-04 Control Word Timeout Function</i> is then carried out. A valid control word triggers the timeout counter.

8-04 Control Word Timeout Function		
Select the timeout function. The timeout function activates when the control word fails to be updated within the time period specified in <i>parameter 8-03 Control Word Timeout Time</i> .		
Option:	Function:	
	<p>NOTICE</p> <p>To change the set-up after a timeout, configure as follows:</p> <ol style="list-style-type: none"> Set <i>parameter 0-10 Active Set-up</i> to [9] <i>Multi set-up</i>. Select the relevant link in <i>parameter 0-12 This Set-up Linked to</i>. 	
[0]	Off	Resumes control via fieldbus (fieldbus or standard), using the most recent control word.
[1]	Freeze output	Freezes output frequency until communication resumes.
[2]	Stop	Stops with auto restart when communication resumes.
[3]	Jogging	Runs the motor at jog frequency until communication resumes.
[4]	Max. speed	Runs the motor at maximum frequency until communication resumes.
[5]	Stop and trip	Stops the motor, then resets the frequency converter to restart: <ul style="list-style-type: none"> Via the fieldbus. Via [Reset]. Via a digital input.

8-04 Control Word Timeout Function		
Select the timeout function. The timeout function activates when the control word fails to be updated within the time period specified in <i>parameter 8-03 Control Word Timeout Time</i> .		
Option:	Function:	
[7]	Select setup 1	Changes the set-up after a control word timeout. If communication resumes after a timeout, <i>parameter 8-05 End-of-Timeout Function</i> either resumes the set-up used before the timeout, or retains the set-up endorsed by the timeout function.
[8]	Select setup 2	See [7] <i>Select set-up 1</i> .
[9]	Select setup 3	See [7] <i>Select set-up 1</i> .
[10]	Select setup 4	See [7] <i>Select set-up 1</i> .
[26]	Trip	

8-05 End-of-Timeout Function		
Option:	Function:	
		Select the action after receiving a valid control word following a timeout. This parameter is active only when <i>parameter 8-04 Control Timeout Function</i> is set to: <ul style="list-style-type: none"> [7] <i>Set-up 1</i>. [8] <i>Set-up 2</i>. [9] <i>Set-up 3</i>. [10] <i>Set-up 4</i>.
[0]	Hold set-up	Retains the set-up selected in <i>parameter 8-04 Control Timeout Function</i> and shows a warning until <i>parameter 8-06 Reset Control Timeout</i> toggles. Then the frequency converter resumes its original set-up.
[1] *	Resume set-up	Resumes the set-up that was active before the timeout.

8-06 Reset Control Word Timeout		
This parameter is active only when [0] <i>Hold set-up</i> has been selected in <i>parameter 8-05 End-of-Timeout Function</i> .		
Option:	Function:	
[0] *	Do not reset	Retains the set-up specified in <i>parameter 8-04 Control Word Timeout Function</i> , following a control word timeout.
[1]	Do reset	Restores the frequency converter to the original set-up following a control word timeout. The frequency converter performs the reset and then immediately reverts to the [0] <i>Do not reset</i> setting.

8-07 Diagnosis Trigger		
Option:	Function:	
		Enables and controls the frequency converter diagnosis function.
[0] *	Disable	Extended diagnosis data is not sent even if the data appears in the frequency converter.
[1]	Trigger on alarms	Extended diagnosis data is sent when 1 or more alarms appear.
[2]	Trigger alarm/warn.	Extended diagnosis data is sent if 1 or more alarms/warnings appear.

8-10 Control Word Profile		
Select the interpretation of the control and status words corresponding to the installed fieldbus. Only the selections valid for the fieldbus installed in slot A are visible in the LCP display. For guidelines in selection of [0] <i>Frequency converter profile</i> and [1] <i>PROFIdrive profile</i> , refer to the <i>design guide</i> of the related product. For more guidelines in the selection of [1] <i>PROFIdrive profile</i> , [5] <i>ODVA</i> , and [7] <i>CANopen DSP 402</i> , see the <i>installation guide</i> for the installed fieldbus.		
Option:	Function:	
[0] *	FC profile	
[1]	PROFIdrive profile	
[5]	ODVA	
[7]	CANopen DSP 402	
[8]	MCO	

8-50 Coasting Select		
Option:	Function:	
		Select control of the coasting function via the terminals (digital input) and/or via the bus.
[0]	Digital input	Activates start command via a digital input.
[1]	Bus	Activates start command via the serial communication port or fieldbus option.
[2]	Logic AND	Activates start command via the fieldbus/serial communication port and 1 extra digital input.
[3] *	Logic OR	Activates start command via the fieldbus/serial communication port or via 1 of the digital inputs.

8-51 Quick Stop Select		
Select control of the quick stop function via the terminals (digital input) and/or via the bus.		
Option:	Function:	
[0]	Digital input	
[1]	Bus	
[2]	Logic AND	
[3] *	Logic OR	

8-52 DC Brake Select		
Option:	Function:	
		Select control of the DC brake via the terminals (digital input) and/or via the fieldbus. NOTICE When parameter 1-10 Motor Construction is set to [1] PM non-salient SPM, only selection [0] Digital input is available.
[0]	Digital input	Activates a start command via a digital input.
[1]	Bus	Activates a start command via the serial communication port or fieldbus option.
[2]	Logic AND	Activates a start command via the fieldbus/serial communication port, and also via 1 of the digital inputs.
[3]	Logic OR	Activates a start command via the fieldbus/serial communication port, or via 1 of the digital inputs.

8-53 Start Select		
Option:	Function:	
		Select control of the frequency converter start function via the terminals (digital input) and/or via the fieldbus.
[0]	Digital input	Activates a start command via a digital input.
[1]	Bus	Activates a start command via the serial communication port or fieldbus option.
[2]	Logic AND	Activates a start command via the fieldbus/serial communication port and also via 1 of the digital inputs.
[3] *	Logic OR	Activates a start command via the fieldbus/serial communication port or via 1 of the digital inputs.

8-54 Reversing Select		
Option:	Function:	
[0]	Digital input	Select control of the frequency converter reverse function via the terminals (digital input) and/or via the fieldbus.
[1]	Bus	Activates the reverse command via the serial communication port or fieldbus option.
[2]	Logic AND	Activates the reverse command via the fieldbus/serial communication port and also via 1 of the digital inputs.
[3]	Logic OR	Activates the reverse command via the fieldbus/serial communication port or via 1 of the digital inputs.

8-55 Set-up Select		
Option:	Function:	
		Select control of the frequency converter set-up selection via the terminals (digital input) and/or via the fieldbus.
[0]	Digital input	Activates the set-up selection via a digital input.
[1]	Bus	Activates the set-up selection via the serial communication port or fieldbus option.
[2]	Logic AND	Activates the set-up selection via the fieldbus/serial communication port and via 1 of the digital inputs.
[3] *	Logic OR	Activates the set-up selection via the fieldbus/serial communication port or via 1 of the digital inputs.

8-56 Preset Reference Select		
Option:	Function:	
		Select control of the preset reference selection via the terminals (digital input) and/or via the fieldbus.
[0]	Digital input	Activates preset reference selection via a digital input.
[1]	Bus	Activates preset reference selection via the serial communication port or fieldbus option.
[2]	Logic AND	Activates preset reference selection via the fieldbus/serial communication port and via 1 of the digital inputs.
[3] *	Logic OR	Activates the preset reference selection via the fieldbus/serial communication port or via 1 of the digital inputs.

8-90 Bus Jog 1 Speed		
Range:	Function:	
100 RPM* [0 - par. 4-13 RPM]	Enter the jog speed. Activate this fixed jog speed via the serial port or fieldbus option.	

8-91 Bus Jog 2 Speed		
Range:	Function:	
200 RPM* [0 - par. 4-13 RPM]	Enter the jog speed. Activate this fixed jog speed via the serial port or fieldbus option.	

6.2 9-** and 16-** PROFIBUS Parameters

9-15 PCD Write Configuration		
Array [10]		
Option:	Function:	
	Select the parameters to be assigned to PCD 3 to 10 of the telegrams. The number of available PCDs depends on the telegram type. The values in PCD 3 to 10 are then written to the selected parameters as data values. Alternatively, specify a standard PROFIBUS telegram in <i>parameter 9-22 Telegram Selection</i> .	
[0]	None	
[302]	Minimum Reference	
[303]	Maximum Reference	
[341]	Ramp 1 Ramp Up Time	
[342]	Ramp 1 Ramp Down Time	
[351]	Ramp 2 Ramp Up Time	
[352]	Ramp 2 Ramp Down Time	
[380]	Jog Ramp Time	
[381]	Quick Stop Ramp Time	
[411]	Motor Speed Low Limit [RPM]	
[412]	Motor Speed Low Limit [Hz]	
[413]	Motor Speed High Limit [RPM]	
[414]	Motor Speed High Limit [Hz]	
[416]	Torque Limit Motor Mode	
[417]	Torque Limit Generator Mode	
[553]	Term. 29 High Ref./Feedb. Value	
[558]	Term. 33 High Ref./Feedb. Value	
[590]	Digital & Relay Bus Control	
[593]	Pulse Out #27 Bus Control	
[595]	Pulse Out #29 Bus Control	
[597]	Pulse Out #X30/6 Bus Control	
[615]	Terminal 53 High Ref./Feedb. Value	
[625]	Terminal 54 High Ref./Feedb. Value	
[653]	Terminal 42 Output Bus Control	
[663]	Terminal X30/8 Output Bus Control	

9-15 PCD Write Configuration		
Array [10]		
Option:	Function:	
[673]	Terminal X45/1 Bus Control	
[683]	Terminal X45/3 Bus Control	
[890]	Bus Jog 1 Speed	
[891]	Bus Jog 2 Speed	
[894]	Bus Feedback 1	
[895]	Bus Feedback 2	
[896]	Bus Feedback 3	
[1680]	Fieldbus CTW 1	
[1682]	Fieldbus REF 1	
[1685]	FC Port CTW 1	
[1686]	FC Port REF 1	

9-16 PCD Read Configuration		
[10] Array		
Option:	Function:	
	Select the parameters to be assigned to PCD 3-10 of the telegrams. The number of available PCDs depend on the telegram type. PCDs 3-10 contain the actual data values of the selected parameters. For standard PROFIBUS telegrams, see <i>parameter 9-22 Telegram Selection</i> .	
[0]	None	
[894]	Bus Feedback 1	
[895]	Bus Feedback 2	
[896]	Bus Feedback 3	
[1397]	Alert Alarm Word	
[1398]	Alert Warning Word	
[1399]	Alert Status Word	
[1500]	Operating hours	
[1501]	Running Hours	
[1502]	kWh Counter	
[1600]	Control Word	
[1601]	Reference [Unit]	
[1602]	Reference [%]	
[1603]	Status Word	
[1605]	Main Actual Value [%]	
[1609]	Custom Readout	
[1610]	Power [kW]	
[1611]	Power [hp]	
[1612]	Motor Voltage	
[1613]	Frequency	
[1614]	Motor current	
[1615]	Frequency [%]	
[1616]	Torque [Nm]	

9-16 PCD Read Configuration		
[10] Array		
Option:	Function:	
[1617]	Speed [RPM]	
[1618]	Motor Thermal	
[1622]	Torque [%]	
[1623]	Motor Shaft Power [kW]	
[1624]	Calibrated Stator Resistance	
[1626]	Power Filtered [kW]	
[1627]	Power Filtered [hp]	
[1630]	DC Link Voltage	
[1632]	Brake Energy /s	
[1633]	Brake Energy Average	
[1634]	Heatsink Temp.	
[1635]	Inverter Thermal	
[1638]	SL Controller State	
[1639]	Control Card Temp.	
[1650]	External Reference	
[1652]	Feedback[Unit]	
[1653]	Digi Pot Reference	
[1654]	Feedback 1 [Unit]	
[1655]	Feedback 2 [Unit]	
[1656]	Feedback 3 [Unit]	
[1660]	Digital Input	
[1661]	Terminal 53 Switch Setting	
[1662]	Analog Input 53	
[1663]	Terminal 54 Switch Setting	
[1664]	Analog Input 54	
[1665]	Analog Output 42 [mA]	
[1666]	Digital Output [bin]	
[1667]	Pulse Input #29 [Hz]	
[1668]	Pulse Input #33 [Hz]	
[1669]	Pulse Output #27 [Hz]	
[1670]	Pulse Output #29 [Hz]	
[1671]	Relay Output [bin]	
[1672]	Counter A	
[1673]	Counter B	
[1675]	Analog In X30/11	
[1676]	Analog In X30/12	
[1677]	Analog Out X30/8 [mA]	
[1678]	Analog Out X45/1 [mA]	
[1679]	Analog Out X45/3 [mA]	
[1684]	Comm. Option STW	
[1685]	FC Port CTW 1	
[1690]	Alarm Word	
[1691]	Alarm Word 2	
[1692]	Warning Word	
[1693]	Warning Word 2	
[1694]	Ext. Status Word	
[1695]	Ext. Status Word 2	
[1696]	Maintenance Word	
[1830]	Analog Input X42/1	
[1831]	Analog Input X42/3	
[1832]	Analog Input X42/5	

9-16 PCD Read Configuration		
[10] Array		
Option:	Function:	
[1833]	Analog Out X42/7 [V]	
[1834]	Analog Out X42/9 [V]	
[1835]	Analog Out X42/11 [V]	
[1836]	Analog Input X48/2 [mA]	
[1837]	Temp. Input X48/4	
[1838]	Temp. Input X48/7	
[1839]	Temp. Input X48/10	
[1850]	Sensorless Readout [unit]	
[1860]	Digital Input 2	

9-18 Node Address		
Range:	Function:	
126* [0 - 126]	Enter the station address in this parameter or, alternatively, in the hardware switch. To adjust the station address in <i>parameter 9-18 Node Address</i> , set the hardware switch to 126 or 127 (all switches set to ON). Otherwise, this parameter shows the actual setting of the switch.	

9-22 Telegram Selection		
Option:	Function:	
		Select a standard PROFIBUS telegram configuration for the frequency converter as an alternative to using the freely configurable telegrams in <i>parameter 9-15 PCD Write Configuration</i> and <i>parameter 9-16 PCD Read Configuration</i> .
[1]	Standard telegram 1	
[101]	PPO 1	
[102]	PPO 2	
[103]	PPO 3	
[104]	PPO 4	
[105]	PPO 5	
[106]	PPO 6	
[107]	PPO 7	
[108] *	PPO 8	

9-23 Parameters for Signals		
Array [1000] Read only		
Option:	Function:	
		This parameter contains a list of signals available for selection in <i>parameter 9-15 PCD Write Configuration</i> and

9-23 Parameters for Signals		
Array [1000]		
Read only		
Option:	Function:	
	<i>parameter 9-16 PCD Read Configuration.</i>	
[0] *	None	
[15]	Readout: actual setup	
[302]	Minimum Reference	
[303]	Maximum Reference	
[312]	Catch up/slow Down Value	
[341]	Ramp 1 Ramp Up Time	
[342]	Ramp 1 Ramp Down Time	
[351]	Ramp 2 Ramp Up Time	
[352]	Ramp 2 Ramp Down Time	
[380]	Jog Ramp Time	
[381]	Quick Stop Ramp Time	
[411]	Motor Speed Low Limit [RPM]	
[412]	Motor Speed Low Limit [Hz]	
[413]	Motor Speed High Limit [RPM]	
[414]	Motor Speed High Limit [Hz]	
[416]	Torque Limit Motor Mode	
[417]	Torque Limit Generator Mode	
[553]	Term. 29 High Ref./Feedb. Value	
[558]	Term. 33 High Ref./Feedb. Value	
[590]	Digital & Relay Bus Control	
[593]	Pulse Out #27 Bus Control	
[595]	Pulse Out #29 Bus Control	
[597]	Pulse Out #X30/6 Bus Control	
[615]	Terminal 53 High Ref./Feedb. Value	
[625]	Terminal 54 High Ref./Feedb. Value	
[653]	Term 42 Output Bus Ctrl	
[663]	Terminal X30/8 Bus Control	
[673]	Terminal X45/1 Bus Control	
[683]	Terminal X45/3 Bus Control	
[748]	PCD Feed Forward	
[890]	Bus Jog 1 Speed	
[891]	Bus Jog 2 Speed	
[1472]	Legacy Alarm Word	
[1473]	Legacy Warning Word	
[1474]	Leg. Ext. Status Word	
[1500]	Operating hours	
[1501]	Running Hours	
[1502]	kWh Counter	
[1600]	Control Word	
[1601]	Reference [Unit]	
[1602]	Reference %	
[1603]	Status Word	
[1605]	Main Actual Value [%]	
[1606]	Absolute Position	
[1609]	Custom Readout	
[1610]	Power [kW]	
[1611]	Power [hp]	
[1612]	Motor Voltage	

9-23 Parameters for Signals		
Array [1000]		
Read only		
Option:	Function:	
[1613]	Frequency	
[1614]	Motor current	
[1615]	Frequency [%]	
[1616]	Torque [Nm]	
[1617]	Speed [RPM]	
[1618]	Motor Thermal	
[1619]	KTY sensor temperature	
[1620]	Motor Angle	
[1621]	Torque [%] High Res.	
[1622]	Torque [%]	
[1623]	Motor Shaft Power [kW]	
[1624]	Calibrated Stator Resistance	
[1625]	Torque [Nm] High	
[1630]	DC Link Voltage	
[1632]	Brake Energy /s	
[1633]	Brake Energy Average	
[1634]	Heatsink Temp.	
[1635]	Inverter Thermal	
[1638]	SL Controller State	
[1639]	Control Card Temp.	
[1645]	Motor Phase U Current	
[1646]	Motor Phase V Current	
[1647]	Motor Phase W Current	
[1648]	Speed Ref. After Ramp [RPM]	
[1650]	External Reference	
[1651]	Pulse Reference	
[1652]	Feedback[Unit]	
[1653]	Digi Pot Reference	
[1657]	Feedback [RPM]	
[1660]	Digital Input	
[1661]	Terminal 53 Switch Setting	
[1662]	Analog Input 53	
[1663]	Terminal 54 Switch Setting	
[1664]	Analog Input 54	
[1665]	Analog Output 42 [mA]	
[1666]	Digital Output [bin]	
[1667]	Freq. Input #29 [Hz]	
[1668]	Freq. Input #33 [Hz]	
[1669]	Pulse Output #27 [Hz]	
[1670]	Pulse Output #29 [Hz]	
[1671]	Relay Output [bin]	
[1672]	Counter A	
[1673]	Counter B	
[1674]	Prec. Stop Counter	
[1675]	Analog In X30/11	
[1676]	Analog In X30/12	
[1677]	Analog Out X30/8 [mA]	
[1678]	Analog Out X45/1 [mA]	
[1679]	Analog Out X45/3 [mA]	
[1680]	Fieldbus CTW 1	

9-23 Parameters for Signals		
Array [1000]		
Read only		
Option:	Function:	
[1682]	Fieldbus REF 1	
[1684]	Comm. Option STW	
[1685]	FC Port CTW 1	
[1686]	FC Port REF 1	
[1687]	Bus Readout Alarm/Warning	
[1689]	Configurable Alarm/Warning Word	
[1690]	Alarm Word	
[1691]	Alarm Word 2	
[1692]	Warning Word	
[1693]	Warning Word 2	
[1694]	Ext. Status Word	
[1836]	Analog Input X48/2 [mA]	
[1837]	Temp. Input X48/4	
[1838]	Temp. Input X48/7	
[1839]	Temp. Input X48/10	
[1843]	Analog Out X49/7	
[1844]	Analog Out X49/9	
[1845]	Analog Out X49/11	
[1860]	Digital Input 2	
[3310]	Sync Factor Master	
[3311]	Sync Factor Slave	
[3401]	PCD 1 Write to MCO	
[3402]	PCD 2 Write to MCO	
[3403]	PCD 3 Write to MCO	
[3404]	PCD 4 Write to MCO	
[3405]	PCD 5 Write to MCO	
[3406]	PCD 6 Write to MCO	
[3407]	PCD 7 Write to MCO	
[3408]	PCD 8 Write to MCO	
[3409]	PCD 9 Write to MCO	
[3410]	PCD 10 Write to MCO	
[3421]	PCD 1 Read from MCO	
[3422]	PCD 2 Read from MCO	
[3423]	PCD 3 Read from MCO	
[3424]	PCD 4 Read from MCO	
[3425]	PCD 5 Read from MCO	
[3426]	PCD 6 Read from MCO	
[3427]	PCD 7 Read from MCO	
[3428]	PCD 8 Read from MCO	
[3429]	PCD 9 Read from MCO	
[3430]	PCD 10 Read from MCO	
[3440]	Digital Inputs	
[3441]	Digital Outputs	
[3450]	Actual Position	
[3451]	Commanded Position	
[3452]	Actual Master Position	
[3453]	Slave Index Position	
[3454]	Master Index Position	
[3455]	Curve Position	
[3456]	Track Error	

9-23 Parameters for Signals		
Array [1000]		
Read only		
Option:	Function:	
[3457]	Synchronizing Error	
[3458]	Actual Velocity	
[3459]	Actual Master Velocity	
[3460]	Synchronizing Status	
[3461]	Axis Status	
[3462]	Program Status	
[3464]	MCO 302 Status	
[3465]	MCO 302 Control	
[3470]	MCO Alarm Word 1	
[3471]	MCO Alarm Word 2	
[3644]	Terminal X49/7 Bus Control	
[3654]	Terminal X49/9 Bus Control	
[3664]	Terminal X49/11 Bus Control	
[4280]	Safe Option Status	
[4282]	Safe Control Word	
[4283]	Safe Status Word	
[4285]	Active Safe Func.	
[4287]	Time Until Manual Test	

9-27 Parameter Edit		
Option:	Function:	
		Edit parameters via: <ul style="list-style-type: none"> • PROFIBUS. • The standard RS485 interface. • The LCP.
[0]	Disabled	Disables editing via PROFIBUS.
[1] *	Enabled	Enables editing via PROFIBUS.

9-28 Process Control		
Option:	Function:	
		Process control (setting of control word, speed reference, and process data) is possible via either PROFIBUS or standard fieldbus, but not both simultaneously. Local control is always possible via the LCP. Control via process control is possible via either terminals or fieldbus depending on the settings in <i>parameter 8-50 Coasting Select</i> to <i>parameter 8-56 Preset Reference Select</i> .
[0]	Disable	Disables process control via PROFIBUS master class 1 and enables process control via standard fieldbus or PROFIBUS master class 2.
[1] *	Enable cyclic master	Enables process control via PROFIBUS master class 1 and disables process control via standard fieldbus or PROFIBUS master class 2.

9-44 Fault Message Counter		
Range:	Function:	
0* [0 - 65535]	Indicates the number of fault events presently stored in <i>parameter 9-45 Fault Code</i> . The buffer capacity is maximum 8 error events. The buffer and counter are set to 0 by reset or power-up.	

9-45 Fault Code		
Range:	Function:	
0* [0 - 0]	This buffer contains the alarm word for all alarms and warnings that have occurred since last reset or power-up. The buffer capacity is maximum 8 error events.	

9-47 Fault Number		
Range:	Function:	
0* [0 - 0]	This buffer contains the alarm word for all alarms and warnings that have occurred since last reset or power-up. The buffer capacity is maximum 8 error events.	

9-52 Fault Situation Counter		
Range:	Function:	
0* [0 - 1000]	Indicates the number of fault events that have occurred since last reset or power-up.	

9-53 Profibus Warning Word		
Read only		
Range:	Function:	
0* [0 - 65535]	This parameter shows PROFIBUS communication warnings. Refer to the <i>VLT® PROFIBUS DP MCA 101 Installation Guide</i> for further information.	

Bit	Description
0	Connection with DP-master is not OK.
1	Not used.
2	FDL (fieldbus data link layer) is not OK.
3	Clear data command received.
4	Actual value is not updated.
5	Baud rate search.
6	PROFIBUS ASIC is not transmitting.
7	Initialization of PROFIBUS is not OK.
8	Frequency converter is tripped.
9	Internal CAN error.
10	Wrong configuration data from PLC.
11	Wrong ID sent by PLC.
12	Internal fault occurred.
13	Not configured.
14	Timeout active.
15	<i>Warning 34, Fieldbus fault active.</i>

Table 6.1 PROFIBUS Warning Word

9-63 Actual Baud Rate		
Option:	Function:	
		This parameter shows the actual PROFIBUS baud rate. The PROFIBUS master automatically sets the baud rate.
[0]	9,6 kbit/s	
[1]	19,2 kbit/s	
[2]	93,75 kbit/s	
[3]	187,5 kbit/s	
[4]	500 kbit/s	
[6]	1500 kbit/s	
[7]	3000 kbit/s	
[8]	6000 kbit/s	
[9]	12000 kbit/s	
[10]	31,25 kbit/s	
[11]	45,45 kbit/s	
[255] *	No baudrate found	

9-64 Device Identification		
Range:	Function:	
0* [0 - 0]	This parameter shows the device identification. Refer to the <i>VLT® PROFIBUS DP MCA 101 Installation Guide</i> for further explanation.	

9-65 Profile Number		
Range:	Function:	
0* [0 - 0]	This parameter contains the profile identification. Byte 1 contains the profile number and byte 2 the version number of the profile.	

9-70 Programming Set-up		
This parameter is unique for LCP and fieldbus. See <i>parameter 0-11 Programming Set-up</i> .		
Option:	Function:	
		Select the set-up to edit.
[0]	Factory setup	Uses default data. This option can be used as a data source to return the other set-ups to a known state.
[1]	Set-up 1	Edits set-up 1.
[2]	Set-up 2	Edits set-up 2.
[3]	Set-up 3	Edits set-up 3.
[4]	Set-up 4	Edits set-up 4.
[9] *	Active Set-up	Follows the active set-up selected in <i>parameter 0-10 Active Set-up</i> .

9-71 Profibus Save Data Values		
Option:	Function:	
		Parameter values changed via PROFIBUS are not automatically stored in non-volatile memory. Use this parameter to activate a function that stores parameter values in the EEPROM non-volatile memory, so changed parameter values are retained at power-down.
[0] *	Off	Deactivates the non-volatile storage function.
[1]	Store all setups	Stores all parameter values for all set-ups in the non-volatile memory. When all parameter values have been stored, the selection returns to [0] Off.
[2]	Store all setups	Stores all parameter values for all set-ups in the non-volatile memory. When all parameter values have been stored, the selection returns to [0] Off.

9-72 ProfibusDriveReset		
Option:	Function:	
[0] *	No action	
[1]	Power-on reset	Resets the frequency converter after power-up, as for power-cycle.
[3]	Comm option reset	Resets the VLT® PROFIBUS DP MCA 101 option only. This is useful after changing certain settings in parameter group 9-** PROFIBUS, for example, <i>parameter 9-18 Node Address</i> . When reset, the frequency converter disappears from the fieldbus, which may cause a communication error from the master.

9-80 Defined Parameters (1)		
Array [116] No LCP access Read only		
Range:		Function:
0*	[0 - 9999]	This parameter shows a list of all the defined frequency converter parameters available for PROFIBUS.

9-81 Defined Parameters (2)		
Array [116] No LCP access Read only		
Range:		Function:
0*	[0 - 9999]	This parameter shows a list of all the defined frequency converter parameters available for PROFIBUS.

9-82 Defined Parameters (3)		
Array [116] No LCP access Read only		
Range:		Function:
0*	[0 - 9999]	This parameter shows a list of all the defined frequency converter parameters available for PROFIBUS.

9-83 Defined Parameters (4)		
Array [116] No LCP access Read only		
Range:		Function:
0*	[0 - 9999]	This parameter shows a list of all the defined frequency converter parameters available for PROFIBUS.

9-90 Changed Parameters (1)		
Array [116] No LCP access Read only		
Range:		Function:
0*	[0 - 9999]	This parameter shows a list of all the frequency converter parameters deviating from default setting.

9-91 Changed Parameters (2)		
Array [116] No LCP access Read only		
Range:		Function:
0*	[0 - 9999]	This parameter shows a list of all the frequency converter parameters deviating from default setting.

9-92 Changed Parameters (3)		
Array [116] No LCP access Read only		
Range:		Function:
0*	[0 - 9999]	This parameter shows a list of all the frequency converter parameters deviating from default setting.

9-93 Changed Parameters (4)		
Range:		Function:
0*	[0 - 9999]	This parameter shows a list of all the frequency converter parameters deviating from default setting.

9-94 Changed Parameters (5)		
Array [116] No LCP Address Read only		
Range:		Function:
0*	[0 - 9999]	This parameter shows a list of all the frequency converter parameters deviating from default setting.

16-84 Comm. Option STW		
Range:		Function:
0*	[0 - 65535]	View the extended fieldbus communication option status word. For more information, refer to the relevant fieldbus manual.

16-90 Alarm Word		
Range:		Function:
0*	[0 - 4294967295]	View the alarm word sent via the serial communication port in hex code.

16-91 Alarm Word 2		
Range:		Function:
0*	[0 - 4294967295]	View the alarm word sent via the serial communication port in hex code.

16-92 Warning Word		
Range:		Function:
0*	[0 - 4294967295]	View the warning word sent via the serial communication port in hex code.

16-93 Warning Word 2		
Range:		Function:
0*	[0 - 4294967295]	View the warning word sent via the serial communication port in hex code.

16-94 Ext. Status Word		
Range:		Function:
0*	[0 - 4294967295]	Returns the extended warning word sent via the serial communication port in hex code.

6.3 PROFIBUS-specific Parameter List

Parameter	Default value	Range	Conversion index	Data type
Parameter 8-01 Control Site	[0] Dig. & ctrl. word	[0-2]	-	UInt8
Parameter 8-02 Control Word Source	[0] FC RS485	[0-4]	-	UInt8
Parameter 8-03 Control Word Timeout Time	1	0.1-18000	-1	UInt32
Parameter 8-04 Control Word Timeout Function	[0] Off	[0-10]	-	UInt8
Parameter 8-05 End-of-Timeout Function	[0] Hold set-up	[0-1]	-	UInt8
Parameter 8-06 Reset Control Word Timeout	[0] Do not reset	[0-1]	-	UInt8
Parameter 8-07 Diagnosis Trigger	[0] Disable	[0-3]	-	UInt8
Parameter 8-10 Control Word Profile	[0] FC profile	[0-x]	-	UInt8
Parameter 8-50 Coasting Select	*[3] Logic OR	[0-3]	-	UInt8
Parameter 8-51 Quick Stop Select	*[3] Logic OR	[0-3]	-	UInt8
Parameter 8-52 DC Brake Select	*[3] Logic OR	[0-3]	-	UInt8
Parameter 8-53 Start Select	*[3] Logic OR	[0-3]	-	UInt8
Parameter 8-54 Reversing Select	*[3] Logic OR	[0-3]	-	UInt8
Parameter 8-55 Set-up Select	*[3] Logic OR	[0-3]	-	UInt8
Parameter 8-56 Preset Reference Select	*[3] Logic OR	[0-3]	-	UInt8
Parameter 8-90 Bus Jog 1 Speed	100 RPM	0- parameter 4-13 Motor Speed High Limit [RPM]	67	UInt16
Parameter 8-91 Bus Jog 2 Speed	200 RPM	0- parameter 4-13 Motor Speed High Limit [RPM]	67	UInt16
Parameter 9-15 PCD Write Configuration	-	-	-	UInt16
Parameter 9-16 PCD Read Configuration	-	-	-	UInt16
Parameter 9-18 Node Address	126	1-126	0	UInt8
Parameter 9-22 Telegram Selection	-	[0-108]	-	UInt8
Parameter 9-23 Parameters for Signals	-	0-573	-	UInt16
Parameter 9-27 Parameter Edit	[1] Enabled	[0-1]	-	UInt16
Parameter 9-28 Process Control	[1] Enable cyclic master	[0-1]	-	UInt16
Parameter 9-44 Fault Message Counter	0	[0-8]	0	UInt16
Parameter 9-45 Fault Code	0	-	-	UInt16
Parameter 9-47 Fault Number	0	-	-	UInt16
Parameter 9-52 Fault Situation Counter	0	0-1000	0	UInt16
Parameter 9-53 Profibus Warning Word	0	16 bits	0	V2
Parameter 9-63 Actual Baud Rate	[255] No baud rate found	9.6-12000 kbits	0	UInt8
Parameter 9-64 Device Identification	0	[0-10]	0	UInt16
Parameter 9-65 Profile Number	0	8 bits	0	UInt8
Parameter 9-70 Edit Set-up	[9] Active set-up	[0-9]	-	UInt8
Parameter 9-71 Profibus Save Data Values	[0] Off	[0-2]	-	UInt8
Parameter 9-72 ProfibusDriveReset	[0] No action	[0-2]	-	UInt8
Parameter 9-80 Defined Parameters (1)	-	0-115	0	UInt16
Parameter 9-81 Defined Parameters (2)	-	0-115	0	UInt16
Parameter 9-82 Defined Parameters (3)	-	0-115	0	UInt16
Parameter 9-83 Defined Parameters (4)	-	0-115	0	UInt16
Parameter 9-90 Changed Parameters (1)	-	0-115	0	UInt16
Parameter 9-91 Changed Parameters (2)	-	0-115	0	UInt16
Parameter 9-92 Changed Parameters (3)	-	0-115	0	UInt16
Parameter 9-93 Changed Parameters (4)	-	0-115	0	UInt16
Parameter 9-94 Changed Parameters (5)	-	0-115	0	UInt16
Parameter 16-84 Comm. Option STW	0	0-FFFF	0	V2

Parameter	Default value	Range	Conversion index	Data type
Parameter 16-90 Alarm Word	0	0-FFFF	0	Uint32
Parameter 16-92 Warning Word	0	0-FFFF	0	Uint32

Table 6.2 PROFIBUS-specific Parameter List

* Indicates a default setting.

Refer to the relevant operating instructions for a comprehensive parameter list.

7 Application Examples

7.1 Example 1: Process Data with PPO Type 6

This example shows how to work with PPO type 6, which consists of control word/status word and reference/main actual value. The PPO also has 2 extra words, which can be programmed to monitor process signals:

	PCV								PCD																			
									1	2	3	4	5	6	7	8	9	10										
	PCA	IND	PVA		CTW	MRV	PCD	PCD	PCD	PCD	PCD	PCD	PCD	PCD	PCD	PCD	PCD											
								STW	MAV																			
Bit number	1	2	3	4	5	6	7	8	9	10	11	12	13	14	15	16	17	18	19	20	21	22	23	24	25	26	27	28
Type 6																												

Table 7.1 Example: Process Data with PPO Type 6

7

The application requires monitoring of the motor torque and digital input, so PCD 3 is set up to read the current motor torque. PCD 4 is set up to monitor the state of an external sensor via the process signal digital input. The sensor is connected to digital input 18.

An external device is also controlled via control word bit 11 and the built-in relay of the frequency converter. Reversing is allowed only when the reversing bit 15 in the control word and the digital input 19 are set to high.

For safety reasons, the frequency converter stops the motor if:

- The PROFIBUS cable is broken.
- The master has a system failure.
- The PLC is in stop mode.

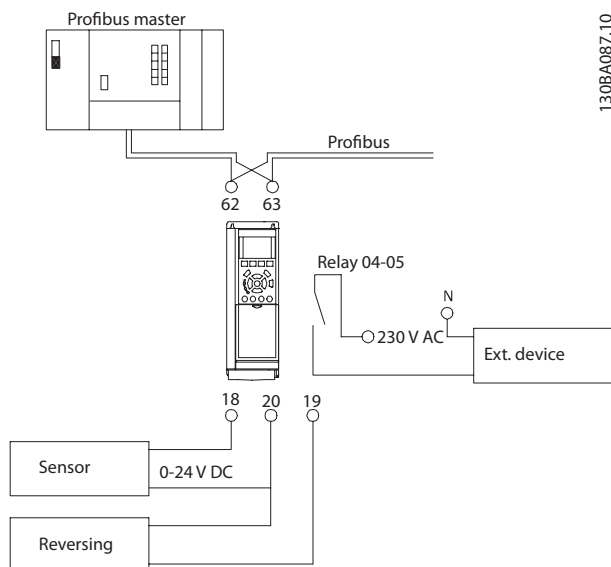

Illustration 7.1 Wiring Diagram

Program the frequency converter as in *Table 7.2*:

Parameter	Setting
Parameter 4-10 Motor Speed Direction	[2] Both directions
Parameter 5-10 Terminal 18 Digital Input	[0] No operation
Parameter 5-11 Terminal 19 Digital Input	[10] Reversing
Parameter 5-40 Function Relay	[36/37] Control word bit 11/12
Parameter 8-03 Control Word Timeout Time	1 s
Parameter 8-04 Control Word Timeout Function	[2] Stop
Parameter 8-10 Control Word Profile	[0] FC Profile
Parameter 8-50 Coasting Select	[1] Bus
Parameter 8-51 Quick Stop Select	[1] Bus
Parameter 8-52 DC Brake Select	[1] Bus
Parameter 8-53 Start Select	[1] Bus
Parameter 8-54 Reversing Select	[2] Logic AND
Parameter 8-55 Set-up Select	[1] Bus
Parameter 8-56 Preset Reference Select	[1] Bus
Parameter 9-16 PCD Read Configuration	[2] Sub index parameter 16-16 Torque [Nm] [3] Sub index parameter 16-60 Digital Input
Parameter 9-18 Node Address	Set the address

7

Table 7.2 Parameter Settings

7.2 Example 2: Control Word Telegram using PPO Type

This example shows how the control word telegram relates to the PLC and the frequency converter, using FC control profile.

The PLC sends the control word telegram to the frequency converter. In the example, PPO Type 3 demonstrates the full range of modules. All the values shown are arbitrary and are provided for demonstration purposes only.

Table 7.3 indicates the bits contained within the control word, and how they are presented as process data in PPO type 3 for this example.

	PCV								PCD											
	PCA		IND		PVA				1		2		3		4		5		6	
									CTW		MRV		PCD		PCD		PCD		PCD	
									04	7C	20	00								
PQW	256		258		260		262		264		266		268		270		272		274	
				master slave				CTW		MRV										
Bit number	15	14	13	12	11	10	9	8	7	6	5	4	3	2	1	0				
	0	0	0	0	0	1	0	0	0	1	1	1	1	1	0	0				
	0				4				7				C							

Table 7.3 Example: Control Word Telegram using PPO Type

Table 7.4 indicates the bit functions and corresponding bit values which are active for this example.

Bit	Bit value=0	Bit value=1	Bit value	
00	Reference value	External selection lsb	0	C
01	Reference value	External selection msb	0	
02	DC brake	Ramp	1	
03	Coasting	Enable	1	
04	Quick stop	Ramp	1	7
05	Freeze output	Ramp enable	1	
06	Ramp stop	Start	1	
07	No function	Reset	0	
08	No function	Jog	0	4
09	Ramp 1	Ramp 2	0	
10	Data not valid	Valid	1	
11	No function	Relay 01 active	0	
12	No function	Relay 02 active	0	0
13	Parameter set-up	Selection lsb	0	
14	Parameter set-up	Selection msb	0	
15	No function	Reversing	0	
Function active				
Function inactive				

Table 7.4 Active Bit Functions for Control Word Telegram using PPO Type

7.3 Example 3: Status Word Telegram using PPO Type

This example shows how the control word telegram relates to the PLC and the frequency converter, using FC control profile.

The PLC sends the control word telegram to the frequency converter. In the example, PPO type 3 demonstrates the full range of modules. All the values shown are arbitrary and are provided for demonstration purposes only.

Table 7.5 indicates the bits contained within the status word, and how they are presented as process data in PPO type 3 for this example.

	PCV								PCD											
	PCA		IND		PVA				1		2		3		4		5		6	
									0F	07	20	00								
PIW	256		258		260		262		264		266		268		270		272		274	
				master slave					STW		MAV									
Bit number	15	14	13	12	11	10	9	8	7	6	5	4	3	2	1	0				
	0	0	0	0	0	1	0	0	0	1	1	1	1	1	0	0				
	0				4				7				C							

Table 7.5 Example: Status Word Telegram using PPO Type

Table 7.6 indicates the bit functions and the corresponding bit values which are active for this example.

Bit	Bit value=0	Bit value=1	Bit value	
00	Control not ready	Control ready	1	7
01	Drive not ready	Drive ready	1	
02	Coasting	Enable	1	
03	No error	Trip	0	
04	No error	Error (no trip)	0	0
05	Reserved	-	0	
06	No error	Trip lock	0	
07	No warning	Warning	0	
08	Speed reference	Speed = reference	1	F
09	Local operation	Bus control	1	
10	Outside frequency range	Within frequency range	1	
11	No operation	In operation	1	
12	Drive OK	Stopped, auto start	0	0
13	Voltage OK	Voltage exceeded	0	
14	Torque OK	Torque exceeded	0	
15	Timers OK	Timers exceeded	0	
Function active				
Function inactive				

7

Table 7.6 Active Bit Functions for Status Word Telegram using PPO Type

7.4 Example 4: PLC Programming

In this example, PPO type 6 is placed in the input/output address, see *Illustration 7.2* and *Table 7.7*.

Slot	Module	Order Number	I Address	Q address	Diagnostic address	Comment
0	FC302	130B1135			2042*	
X1	Interface				2041*	
X1	Port 1				2040*	
1	PPO Type 6 PCD	130B1135			2039*	
1.1	Parameter Access Point				2039*	
1.2	PPO Type 6 PCD		256...263	256...263		

Illustration 7.2 FC 302 and PPO Type 6 PCD

Input address	256-257	258-259	260-261	262-263	Output address	256-257	258-259	260-261	262-263
Set-up	Status word	MAV	Motor torque	Digital input	Set-up	Control word	Reference	Not used	Not used

Table 7.7 Input/Output Address Set-up

This network sends a start command (047C hex) and a reference (2000 hex) of 50% to the frequency converter.

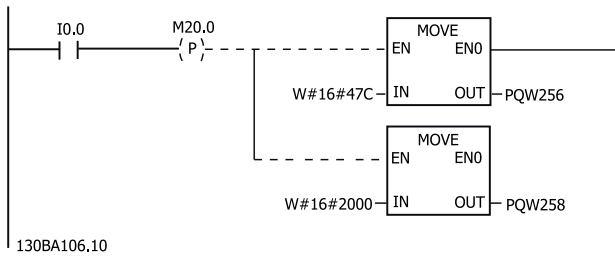

Illustration 7.3 Network Sends a Start Command and a Reference of 50% to the Frequency Converter.

This network activates relay 02.

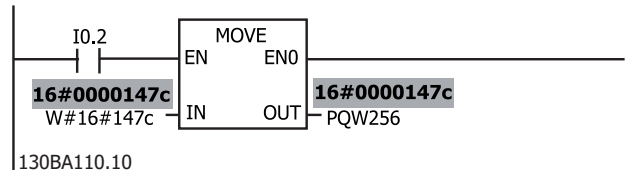

Illustration 7.7 Network Activates Relay 02

7

This network reads the motor torque from the frequency converter. A new reference is sent to the frequency converter because the motor torque (86.0%) is higher than the compared value.

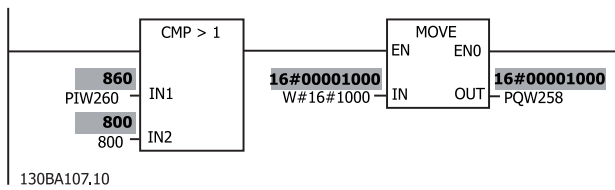

Illustration 7.4 Network Reads the Motor Torque from the Frequency Converter

This network reads the status on the digital inputs from the frequency converter. If digital input 18 is On, it stops the frequency converter.

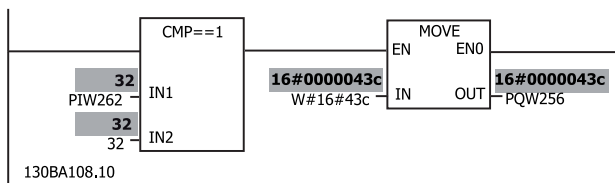

Illustration 7.5 Network Reads the Status on the Digital Inputs from the Frequency Converter

This network reverses the motor when digital input 19 is ON, because parameter 8-54 Reversing Select is programmed to Logic AND.

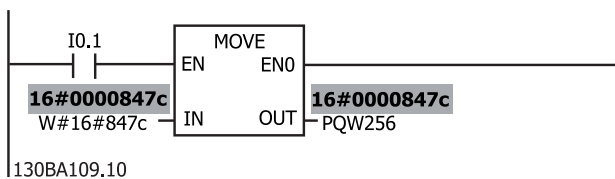

Illustration 7.6 Network Reverses the Motor When Digital Input 19 is ON

8 Troubleshooting

8.1 Diagnosis

VL7[®] PROFIBUS DP MCA 101 provides a flexible way of performing diagnosis of slave units, based on diagnosis messages.

During normal cyclic data exchange:

1. The slave sets a diagnosis bit, which requests the master to send a diagnosis message during the next scan cycle, instead of the normal data exchange.
2. The slave answers the master with a diagnosis message consisting of standard diagnosis information, 6 bytes, and possibly extended, vendor-specific, diagnosis information. The standard diagnosis messages cover a limited range of general diagnosis possibilities, whereas the extended diagnosis function offers detailed messaging specific to the frequency converter.

See *chapter 8.3 Warnings and Alarms* for the extended diagnosis messages for the frequency converter.

A master or a network analyzing tool is able to translate these diagnosis words into real text messages using the GSD file.

NOTICE

DP-V1 diagnosis is supported for PROFIBUS SW version 2.X and later versions. The default setting of the PROFIBUS option is DP-V1 diagnosis.

When DP-V0 diagnosis is required, change the setting under *DP slave Properties*.

8.2 No Response to Control Signals

Check that:

- The control word is valid.
When bit 10=0 in the control word, the frequency converter does not accept the control word. The default setting is bit 10=1. Set bit 10=1 via the PLC.
- The relationship between bits in the control word and the terminal I/Os is correct.
Check the logical relationship in the frequency converter. Set the logic to bit 3=1 and digital input=1 to achieve a successful start.

Select the FC control mode, digital input, and/or serial communication, using *parameter 8-50 Coasting Select* to *parameter 8-56 Preset Reference Select*.

Selecting control mode for *parameter 8-50 Coasting Select*, *parameter 8-51 Quick Stop Select*, and *parameter 8-52 DC Brake Select*:

If [0] *Digital input* is selected, the terminals control the coast and DC brake functions.

NOTICE

Coasting, quick stop, and DC brake functions are active for logic 0.

Terminal	Bit 02/03/04	Function
0	0	Coast/DC brake/Q-stop
0	1	Coast/DC brake/Q-stop
1	0	No coast/DC brake/Q-stop
1	1	No coast/DC brake/Q-stop

Table 8.1 [0] Digital Input

If [1] *Serial communication* is selected, commands are activated only when given via serial communication.

Terminal	Bit 02/03/04	Function
0	0	Coast/DC brake/Q-stop
0	1	No coast/DC brake/Q-stop
1	0	Coast/DC brake/Q-stop
1	1	No coast/DC brake/Q-stop

Table 8.2 [1] Serial Communication

If [2] *Logic AND* is selected, activate both signals to perform the function.

Terminal	Bit 02/03/04	Function
0	0	Coast/DC brake/Q-stop
0	1	No coast/DC brake/Q-stop
1	0	No coast/DC brake/Q-stop
1	1	No coast/DC brake/Q-stop

Table 8.3 [2] Logic AND

If [3] *Logic OR* is selected, activation of 1 signal activates the function.

Terminal	Bit 02/03/04	Function
0	0	Coast/DC brake/Q-stop
0	1	Coast/DC brake/Q-stop
1	0	Coast/DC brake/Q-stop
1	1	No coast/DC brake/Q-stop

Table 8.4 [3] Logic OR

Selecting control mode for parameter 8-53 Start Select and parameter 8-54 Reversing Select:

If [0] Digital input is selected, the terminals control the start and reversing functions.

Terminal	Bit 06/15	Function
0	0	Stop/clockwise
0	1	Stop/counterclockwise
1	0	Start/clockwise
1	1	Start/clockwise

Table 8.5 [0] Digital Input

If [1] Serial communication is selected, activate commands only when given via serial communication.

Terminal	Bit 02/03/04	Function
0	0	Stop/counterclockwise
0	1	Start/clockwise
1	0	Stop/counterclockwise
1	1	Start/clockwise

Table 8.6 [1] Serial Communication

If [2] Logic AND is selected, activate both signals to perform the function.

Terminal	Bit 02/03/04	Function
0	0	Stop/counterclockwise
0	1	Stop/counterclockwise
1	0	Stop/counterclockwise
1	1	Start/clockwise

Table 8.7 [2] Logic AND

If [3] Logic OR is selected, activation of 1 signal activates the function.

Terminal	Bit 02/03/04	Function
0	0	Stop/counterclockwise
0	1	Start/clockwise
1	0	Start/clockwise
1	1	Start/clockwise

Table 8.8 [3] Logic OR

Selecting control mode for parameter 8-55 Set-up Select and parameter 8-56 Preset Reference Select:

If [0] Digital input is selected, the terminals control the set-up and preset reference functions.

Terminal		Bit 00/01, 13/14		Function
Msb	Lsb	Msb	Lsb	Preset reference, set-up number
0	0	0	0	1
0	0	0	1	1
0	0	1	0	1
0	0	1	1	1
0	1	0	0	2
0	1	0	1	2
0	1	1	0	2
0	1	1	1	2
1	0	0	0	3
1	0	0	1	3
1	0	1	0	3
1	0	1	1	3
1	1	0	0	4
1	1	0	1	4
1	1	1	0	4
1	1	1	1	4

Table 8.9 [0] Digital Input

If [1] Serial communication is selected, activate commands only when given via serial communication.

Terminal		Bit 00/01, 13/14		Function
Msb	Lsb	Msb	Lsb	Preset reference, set-up number
0	0	0	0	1
0	0	0	1	2
0	0	1	0	3
0	0	1	1	4
0	1	0	0	1
0	1	0	1	2
0	1	1	0	3
0	1	1	1	4
1	0	0	0	1
1	0	0	1	2
1	0	1	0	3
1	0	1	1	4
1	1	0	0	1
1	1	0	1	2
1	1	1	0	3
1	1	1	1	4

Table 8.10 [1] Serial Communication

If [2] Logic AND is selected, activate both signals to perform the function.

Terminal		Bit 00/01, 13/14		Function
Msb	Lsb	Msb	Lsb	Preset reference, set-up number
0	0	0	0	1
0	0	0	1	1
0	0	1	0	1
0	0	1	1	1
0	1	0	0	1
0	1	0	1	2
0	1	1	0	1
0	1	1	1	2
1	0	0	0	1
1	0	0	1	1
1	0	1	0	3
1	0	1	1	3
1	1	0	0	1
1	1	0	1	2
1	1	1	0	3
1	1	1	1	4

Table 8.11 [2] Logic AND

If [3] Logic OR is selected, activation of 1 signal activates the function.

Terminal		Bit 00/01, 13/14		Function
Msb	Lsb	Msb	Lsb	Preset reference, set-up number
0	0	0	0	1
0	0	0	1	2
0	0	1	0	3
0	0	1	1	4
0	1	0	0	2
0	1	0	1	2
0	1	1	0	4
0	1	1	1	4
1	0	0	0	3
1	0	0	1	4
1	0	1	0	3
1	0	1	1	4
1	1	0	0	4
1	1	0	1	4
1	1	1	0	4

Table 8.12 [3] Logic OR

8.3 Warnings and Alarms

NOTICE

Refer to the relevant *operating instructions* for an overview of warning and alarm types, and for the full list of warnings and alarms.

Alarm word, warning word, and PROFIBUS warning word are shown on the frequency converter display in hex format. When there is more than 1 warning or alarm, the sum of all warnings or alarms is shown. Alarm word, warning word, and PROFIBUS warning word can also be shown using the fieldbus in *parameter 16-90 Alarm Word*, *parameter 16-92 Warning Word*, and *parameter 9-53 Profibus Warning Word*.

Bit (hex)	Dec	Unit diagnose bit	Alarm word (<i>parameter 16-90 Alarm Word</i>)	Alarm word 2	Alarm number
00000001	1	48	Brake check	ServiceTrip, Read/Write	28
00000002	2	49	Power card overtemperature	ServiceTrip (reserved)	29
00000004	4	50	Earth fault	ServiceTrip, Typecode/ Sparepart	14
00000008	8	51	Control card over temperature	ServiceTrip (reserved)	65
00000010	16	52	Control word timeout	ServiceTrip (reserved)	18
00000020	32	53	Over current	–	13
00000040	64	54	Torque limit	–	12
00000080	128	55	Motor thermistor over temp.	–	11
00000100	256	40	Motor ETR over temperature	–	10
00000200	512	41	Inverter overloaded	–	9
00000400	1024	42	DC-link undervoltage	–	8
00000800	2048	43	DC-link overvoltage	–	7
00001000	4096	44	Short circuit	–	16
00002000	8192	45	Inrush fault	–	33
00004000	16384	46	Mains phase loss	–	4
00008000	32768	47	AMA not OK	–	50
00010000	65536	32	Live zero error	–	2
00020000	131072	33	Internal fault	KTY error	38
00040000	262144	34	Brake overload	Fans error	26
00080000	524288	35	Motor phase U is missing	ECB error	30
00100000	1048576	36	Motor phase V is missing	–	31
00200000	2097152	37	Motor phase W is missing	–	32
00400000	4194304	38	Fieldbus comm. fault	–	34
00800000	8388608	39	24 V supply fault	–	47
01000000	16777216	24	Mains failure	–	36
02000000	33554432	25	1.8 V supply fault	–	48
04000000	67108864	26	Brake resistor short circuit	–	25
08000000	134217728	27	Brake chopper fault	–	27
10000000	268435456	28	Option change	–	67
20000000	536870912	29	Drive initialisation	–	80
40000000	1073741824	30	Safe stop	PTC 1 Safe Stop (A71)	68
80000000	2147483648	31	Mechanical brake low	Dangerous Failure (A72)	63

Table 8.13 *Parameter 16-90 Alarm Word*

Bit (hex)	Dec	Unit diagnose bit	Warning word (<i>parameter 16-92 Warning Word</i>)	Warning word 2	Warning number
00000001	1	112	Brake check	–	28
00000002	2	113	Power card overtemperature	–	29
00000004	4	114	Earth fault	–	14
00000008	8	115	Control card	–	65
00000010	16	116	Control word timeout	–	18
00000020	32	117	Over current	–	13
00000040	64	118	Torque limit	–	12
00000080	128	119	Motor thermistor over temp.	–	11
00000100	256	104	Motor ETR over temperature	–	10
00000200	512	105	Inverter overloaded	–	9
00000400	1024	106	DC-link undervoltage	–	8
00000800	2048	107	DC-link overvoltage	–	7
00001000	4096	108	DC -link voltage low	–	6
00002000	8192	109	DC -link voltage high	–	5
00004000	16384	110	Mains phase loss	–	4
00008000	32768	111	No motor	–	3
00010000	65536	96	Live zero error	–	2
00020000	131072	97	10 V low	KTY Warn	1
00040000	262144	98	Brake overload	Fans Warn	26
00080000	524288	99	Brake resistor short circuit	ECB Warn	25
00100000	1048576	100	Brake chopper fault	–	27
00200000	2097152	101	Speed limit	–	49
00400000	4194304	102	Fieldbus comm. fault	–	34
00800000	8388608	103	24 V supply fault	–	47
01000000	16777216	88	Mains failure	–	36
02000000	33554432	89	Current limit	–	59
04000000	67108864	90	Low temperature	–	66
08000000	134217728	91	Voltage limit	–	64
10000000	268435456	92	Encoder loss	–	61
20000000	536870912	93	Output frequency limit	–	62
40000000	1073741824	94	Unused	PTC 1 Safe Stop (W71)	–
80000000	2147483648	95	Warning word 2 (ext. stat. word)	–	–

Table 8.14 Parameter 16-92 Warning Word

Bit	hex	Dec	Extended status word (parameter 16-94 Ext. Status Word)
0	00000001	1	Ramping
1	00000002	2	AMA running
2	00000004	4	Start CW/CCW
3	00000008	8	Slow down
4	00000010	16	Catch up
5	00000020	32	Feedback high
6	00000040	64	Feedback low
7	00000080	128	Output current high
8	00000100	256	Output current low
9	00000200	512	Output freq hgh
10	00000400	1024	Output freq low
11	00000800	2048	Brake check OK
12	00001000	4096	Braking max
13	00002000	8192	Braking
14	00004000	16384	Out of speed range
15	00008000	32768	OVC active
16	00010000	65536	AC brake
17	00020000	131072	Password timelock
18	00040000	262144	Password protection
19	00080000	524288	–
20	00100000	1048576	–
21	00200000	2097152	–
22	00400000	4194304	Unused
23	00800000	8388608	Unused
24	01000000	16777216	Unused
25	02000000	33554432	Unused
26	04000000	67108864	Unused
27	08000000	134217728	Unused
28	10000000	268435456	Unused
29	20000000	536870912	Unused
30	40000000	1073741824	Unused
31	80000000	2147483648	Unused

Table 8.15 Extended Status Word

Bit (hex)	Unit diagnose bit	PROFIBUS warning word (parameter 9-53 Profibus Warning Word)
00000001	160	Connection with DP-master is not OK.
00000002	161	Unused.
00000004	162	FDL (fieldbus data link layer) is not OK.
00000008	163	Clear data command received.
00000010	164	Actual value is not updated.
00000020	165	Baud rate search.
00000040	166	PROFIBUS ASIC is not transmitting.
00000080	167	Initializing of PROFIBUS is not OK.
00000100	152	Frequency converter is tripped.
00000200	153	Internal CAN error.
00000400	154	Wrong configuration data from PLC.
00000800	155	Wrong ID sent by PLC.
00001000	156	Internal fault occurred.
00002000	157	Not configured.
00004000	158	Timeout active.
00008000	159	Warning 34, Fieldbus fault active

Table 8.16 Parameter 9-53 Profibus Warning Word

Bit (hex)	Communication option STW (parameter 16-84 Comm. Option STW)
00000001	Parameterization OK.
00000002	Configuration OK.
00000004	Clear mode active.
00000008	Baud rate search.
00000010	Waiting for parameterization.
00000020	Waiting for configuration.
00000040	In data exchange.
00000080	Not used.
00000100	Not used.
00000200	Not used.
00000400	Not used.
00000800	MCL2/1 connected.
00001000	MCL2/2 connected.
00002000	MCL2/3 connected.
00004000	Data transport active.
00008000	Unused.

Table 8.17 Parameter 16-84 Comm. Option STW

NOTICE

Parameter 16-84 Comm. Option STW is not part of extended diagnosis.

For diagnosis, read out the alarm words, warning words, and extended status words via fieldbus or optional fieldbus.

8.4 Fault Messages via DP Diagnosis

The standard DP function features an online diagnosis, which is active during DP initialization and data exchange mode.

8.5 Extended Diagnosis

Receive the extended diagnosis function, alarm, and warning information from the frequency converter. The setting of *parameter 8-07 Diagnosis Trigger* determines which frequency converter events trigger the extended diagnosis function:

- When *parameter 8-07 Diagnosis Trigger* is set to [0] *Disable*, no extended diagnosis data is sent regardless of whether it appears in the frequency converter or not.
- When *parameter 8-07 Diagnosis Trigger* is set to [1] *Alarms*, extended diagnosis data is sent when 1 or more alarms arrive in the alarm *parameter 16-90 Alarm Word* or *parameter 9-53 Profibus Warning Word*.

When *parameter 8-06 Reset Control Word Timeout* is set to [2] *Alarms/Warnings*, extended diagnosis data is sent if 1 or more alarms/warnings arrive in the alarm *parameter 16-90 Alarm Word* or *parameter 9-53 Profibus Warning Word*, or in the warning *parameter 16-92 Warning Word*.

The extended diagnosis sequence is as follows:

If an alarm or warning appears, the frequency converter sends a high-priority message to the master via the output data telegram. The master then sends a request for extended diagnosis information, to which the frequency converter replies. When the alarm or warning disappears, the frequency converter again sends a message to the master, and on the following request from the master, returns a standard DP diagnosis frame (6 bytes).

Byte	Bit number	Name
0-5	-	Standard DP diagnosis data.
6	-	PDU length.
7	0-7	Status type=0x81.
8	8-15	Slot=0.
9	16-23	Status information.
10	24-31	<i>Parameter 16-90 Alarm Word.</i>
11	32-39	<i>Parameter 16-90 Alarm Word.</i>
12	40-47	<i>Parameter 16-90 Alarm Word.</i>
13	48-55	<i>Parameter 16-90 Alarm Word.</i>
14	56-63	Reserved for future use.
15	64-71	Reserved for future use.
16	72-79	Reserved for future use.
17	80-87	Reserved for future use.
18	88-95	<i>Parameter 16-92 Warning Word.</i>
19	96-103	<i>Parameter 16-92 Warning Word.</i>
20	104-111	<i>Parameter 16-92 Warning Word.</i>
21	112-119	<i>Parameter 16-92 Warning Word.</i>
22	120-127	Reserved for future use.
23	128-135	Reserved for future use.
24	136-143	Reserved for future use.
25	144-151	Reserved for future use.
26	152-159	<i>Parameter 9-53 Profibus Warning Word.</i>
27	160-167	<i>Parameter 9-53 Profibus Warning Word.</i>
28	168-175	Reserved for future use.
29	176-183	Reserved for future use.
30	184-191	Reserved for future use.
31	192-199	Reserved for future use.

Table 8.18 Content of the Extended Diagnosis Frame

Index

A

Abbreviations..... 5
 Additional resources..... 3
 Alarm word..... 56
 Alarms..... 56
 Approvals..... 4

C

Certifications..... 4
 Complete description..... 30
 Configuration..... 36
 Control profile..... 16
 Control word..... 17
 Conventions..... 5
 CTW..... 17

D

Data store..... 25
 Data types, supported..... 34
 Discharge time..... 6

E

Extended diagnosis..... 59

F

Fault messages via DP diagnosis..... 58
 FC control mode
 Digital input terminals..... 16
 Field PCD normalization..... 30
 Freeze/unfreeze..... 24
 Frequency converter parameters..... 11

G

GSD file..... 9

H

High voltage..... 6

I

ID extension..... 30
 Identifier ID..... 30

L

Leakage current..... 7
 LEDs..... 12

Load sharing..... 6
 Lower limit..... 30

M

MCT 10 Set-up Software..... 4

N

Name..... 30
 Number of array elements..... 30

P

Parameter access..... 25
 PCA handling..... 32
 PCA parameter characteristic..... 32
 PCD..... 33
 PCD reference parameter..... 30
 PCV..... 33
 PCV parameter access..... 31
 PPO types..... 13
 Process control data..... 15
 Process control operation..... 16
 Process data..... 15
 Process status data..... 15
 PROFIBUS address..... 8
 PROFIBUS DP-V1
 Acyclic parameter channel..... 27
 Attribute description..... 30
 Data exchange..... 26
 Fault codes..... 31
 Master class 1 connection..... 26
 Master class 2 connection..... 26
 Parameter access..... 27
 Read/write services..... 27
 Request ID..... 29
 Request reference..... 29
 Request/response attributes..... 28
 Response ID..... 29
 Supported data types..... 31
 Value..... 31
 PROFIdrive profile (CTW)..... 17
 PROFIdrive state transition diagram..... 20

Q

Qualified personnel..... 6

R

RC content..... 32
 Read/write in double word format..... 25
 Reference handling..... 15
 Request/response handling..... 32

S

Safety.....	7
Services overview.....	26
Size attribute.....	34
Status word.....	18
Symbols.....	5
Sync/unsync.....	23

T

Termination switch.....	8
-------------------------	---

U

Unintended start.....	6
Upper limit.....	30

W

Warning word.....	56
Warnings.....	56



.....
Danfoss can accept no responsibility for possible errors in catalogues, brochures and other printed material. Danfoss reserves the right to alter its products without notice. This also applies to products already on order provided that such alterations can be made without subsequential changes being necessary in specifications already agreed. All trademarks in this material are property of the respective companies. Danfoss and the Danfoss logotype are trademarks of Danfoss A/S. All rights reserved.
.....

Danfoss A/S
Ulsnaes 1
DK-6300 Graasten
vlt-drives.danfoss.com

